

SRM210 | V-Class
SRM212 | V-Class
SRM215 | V-Class

High-Performance Powered Loudspeaker Series

OWNER'S MANUAL



Important Safety Instructions

1. Read these instructions.
2. Keep these instructions.
3. Heed all warnings.
4. Follow all instructions.
5. Do not use this apparatus near water.
6. Clean only with a dry cloth.
7. Do not block any ventilation openings. Install in accordance with the manufacturer's instructions.
8. Minimum distance (5 cm) around the apparatus for sufficient ventilation. The ventilation should not be impeded by covering the ventilation openings with items, such as newspapers, table-cloths, curtains, etc.
9. Do not install near any heat sources such as radiators, heat registers, stoves, or other apparatus (including amplifiers) that produce heat.
10. No naked flame sources, such as lighted candles, should be placed on the apparatus.
11. Do not defeat the safety purpose of the polarized or grounding-type plug. A polarized plug has two blades with one wider than the other. A grounding-type plug has two blades and a third grounding prong. The wide blade or the third prong are provided for your safety. If the provided plug does not fit into your outlet, consult an electrician for replacement of the obsolete outlet.
12. Protect the power cord from being walked on or pinched particularly at plugs, convenience receptacles, and the point where they exit from the apparatus.
13. Only use attachments/accessories specified by the manufacturer.
14. Use only with a cart, stand, tripod, bracket, or table specified by the manufacturer, or sold with the apparatus. When a cart is used, use caution when moving the cart/apparatus combination to avoid injury from tip-over.
15. Unplug this apparatus during lightning storms or when unused for long periods of time.
16. Refer all servicing to qualified service personnel. Servicing is required when the apparatus has been damaged in any way, such as power-supply cord or plug is damaged, liquid has been spilled or objects have fallen into the apparatus, the apparatus has been exposed to rain or moisture, does not operate normally, or has been dropped.
17. This apparatus shall not be exposed to dripping or splashing, and no object filled with liquids, such as vases or beer glasses, shall be placed on the apparatus.
18. Do not overload wall outlets and extension cords as this can result in a risk of fire or electric shock.



CAUTION

RISK OF ELECTRIC SHOCK! DO NOT OPEN!

CAUTION: TO REDUCE THE RISK OF ELECTRIC SHOCK DO NOT REMOVE COVER (OR BACK). NO USER-SERVICEABLE PARTS INSIDE. REFER SERVICING TO QUALIFIED PERSONNEL.



The lightning flash with arrowhead symbol within an equilateral triangle is intended to alert the user to the presence of uninsulated "dangerous voltage" within the product's enclosure, that may be of significant magnitude to constitute a risk of electric shock to persons.



The exclamation point within an equilateral triangle is intended to alert the user of the presence of important operating and maintaining (servicing) instructions in the literature accompanying the appliance.

WARNING — To reduce the risk of fire or electric shock, do not expose this apparatus to rain or moisture.

CAUTION — To prevent electric shock hazard, do not connect to mains power supply while grille is removed.

Laite on liitettävä suojakoskettimilla varustettuun pistorasiaan.

Apparatet stikprop skal tilsluttes en stikkontakt med jord, som giver forbindelse til stikkoppens jord.

Apparatet må tilkoples jordet stikkontakt.

Apparaten skall anslutas till jordat uttag.

19. This apparatus has been designed with Class-I construction and must be connected to a mains socket outlet with a protective earthing connection (the third grounding prong).
 20. This apparatus has been equipped with a rocker-style AC mains power switch. This switch is located on the rear panel and should remain readily accessible to the user.
 21. The MAINS plug or an appliance coupler is used as the disconnect device, so the disconnect device shall remain readily operable.
 22. The use of apparatus is in moderate climates.
 23. This device should be installed and operated with minimum distance 20cm between the radiator & your body.
- The product can be sold in all EU countries.
Bluetooth transmitter Power: ≤19dBm
Bluetooth transmitter frequency range: 2.402 – 2.480 GHz
24. **NOTE:** This equipment has been tested and found to comply with the limits for a Class A digital device, pursuant to part 15 of the FCC Rules. These limits are designed to provide reasonable protection against harmful interference when the equipment is operated in a commercial environment. This equipment generates, uses, and can radiate radio frequency energy and, if not installed and used in accordance with the instruction manual, may cause harmful interference to radio communications. Operation of this equipment in a residential area is likely to cause harmful interference in which case the user will be required to correct the interference at his own expense.

NOTE: Equipment meeting Class A requirements may not offer adequate protection to broadcast services within a residential environment.

CAUTION: Changes or modifications to this device not expressly approved by LOUD Audio, LLC could void the user's authority to operate the equipment under FCC rules.

25. This apparatus does not exceed the Class A/Class B (whichever is applicable) limits for radio noise emissions from digital apparatus as set out in the radio interference regulations of the Canadian Department of Communications.
Canada ICES-003(A)/NMB-003(A)

ATTENTION — *Le présent appareil numérique n'émet pas de bruits radioélectriques dépassant les limites applicables aux appareils numériques de class A/de class B (selon le cas) prescrites dans le règlement sur le brouillage radioélectrique édicté par les ministere des communications du Canada.*

26. Exposure to extremely high noise levels may cause permanent hearing loss. Individuals vary considerably in susceptibility to noise-induced hearing loss, but nearly everyone will lose some hearing if exposed to sufficiently intense noise for a period of time. The U.S. Government's Occupational Safety and Health Administration (OSHA) has specified the permissible noise level exposures shown in the following chart.

According to OSHA, any exposure in excess of these permissible limits could result in some hearing loss. To ensure against potentially dangerous exposure to high sound pressure levels, it is recommended that all persons exposed to equipment capable of producing high sound pressure levels use hearing protectors while the equipment is in operation. Ear plugs or protectors in the ear canals or over the ears must be worn when operating the equipment in order to prevent permanent hearing loss if exposure is in excess of the limits set forth here:

Duration, per day in hours	Sound Level dBA, Slow Response	Typical Example
8	90	Duo in small club
6	92	
4	95	Subway Train
3	97	
2	100	Very loud classical music
1.5	102	
1	105	Matt screaming at Troy about deadlines
0.5	110	
0.25 or less	115	Loudest parts at a rock concert



Correct disposal of this product: This symbol indicates that this product should not be disposed of with your household waste, according to the WEEE directive (2012/19/EU) and your national law. This product should be handed over to an authorized collection site for recycling waste electrical and electronic equipment (EEE). Improper handling of this type of waste could have a possible negative impact on the environment and human health due to potentially hazardous substances that are generally associated with EEE. At the same time, your cooperation in the correct disposal of this product will contribute to the effective usage of natural resources. For more information about where you can drop off your waste equipment for recycling, please contact your local city office, waste authority, or your household waste disposal service.

Features

Industry-leading 2000W Class-D amplifiers

- Our most advanced amplifier platform ever, delivering incredible stability, headroom, and audio fidelity
- Unrivaled reliability and rock-solid operation can withstand the most demanding applications
- Universal power supply (100-240VAC) with Power Factor Correction for stable operation even with unstable AC power

Advanced Impulse™ DSP – Proprietary Acoustic Tuning

- Crystal clear sound across the entire dispersion zone means the whole room is the sweet spot
- Precision crossover and transducer time-alignment ensures balanced and accurate sound

Intelligent Bass Management™

- Our proprietary LF management technology maintains tonal balance and output level when operating at very high volumes while keeping the bass tight and punchy

Custom Sym-X™ Horn

- Allows for total efficiency from the HF transducer minimizing distortion and increasing output
- Creates a perfectly symmetrical, flat response at the crossover point for exceptionally smooth midrange
- The horn-loading frequency is set below the drivers' LF capability allowing for maximum efficiency and optimal performance at the crossover point

High-Performance Custom Transducers

- Large, powerful magnets partner with robust motors, voice coils and spiders to provide the highest possible efficiency and transient accuracy
- Additional cooling vents surrounding the specially designed voice coil plus directional cabinet porting ensures maximum heat dispersion and reliability
- Premium polymer high-frequency driver provides the flattest possible response for incredibly smooth highs that sound natural and balanced

Transparent System Limiting and Protection

- Dedicated processing module monitors and protects the amplifier in real time
- Sound quality and tonal balance is maintained even under heavy limiting
- Utilizing powerful multi-band compression, the amplifier can target specific frequency ranges to prevent the system from being overloaded rather than turn everything down at the expense of overall output
- Input limiting keeps your source signal in check so if you're sending audio that's a bit too hot, the speaker will cool it down

SRM Mix Control™ Built-in 4-Channel Digital Mixer with Bluetooth®

- Dual independent channels that support mic, line, and instrument signals
- Dedicated 1/8" stereo aux channel
- Stream music from any Bluetooth® enabled device
- High-contrast full color display for easy single-knob access to mixer and processing
- Adjust channel levels and EQ
- Application and venue specific voicing modes
- Alignment delay – up to 100 feet
- Save and recall up to 10 user presets
- Screensaver plus dimmer and contrast control
- System lock with 4-digit passcode
- Change front LED function: Green, white, off, signal present, multi (cycle through colors)

Complete Wireless Control via the SRM Connect™ App

- The SRM Connect™ app gives you access to all adjustments and settings including EQ, levels, and presets

Wirelessly link two SRM | V-Class speakers together for music streaming applications plus complete control over both speakers

- The latest Bluetooth technology allows up to 100 meters of range between linked speakers
- Stereo or dual zone linking modes allows discrete control over the inputs and outputs of the entire system across two rooms or zones
- Creates an incredibly clean setup in minutes

Versatile configuration options

- Dual-angled cabinet design allows for use as a high-performance floor monitor
- Dual angle pole-mount provides optimal coverage and minimal reflections in most venues. The 7-degree downward tilt is perfect for when the speakers are on elevated stages.
- M10 flypoints for professional installation



Like us



Follow us



Watch our dang videos

Introduction

SRM | V-Class High-Performance Powered Loudspeakers are a whole new tier of SRM portable loudspeakers that aren't just made to get the job done, but to get it done better than anything else with unmatched clarity, output, and control packaged into sleek, rugged enclosures.

Robust 2000W amplifiers with our Advanced Impulse™ DSP tuning and Intelligent Bass Management™ deliver a consistent listening experience to your whole audience even at extreme volumes.

A built-in digital mixer with full-color display features Bluetooth® streaming and powerful processing plus complete wireless control via the SRM Connect™ app.

Experience the new definition of high-performance for DJs, clubs, HoW, rental, and beyond with SRM | V-Class.

How to Use This Manual:

After this introduction, a getting started guide will help you get things set up fast. The hookup diagrams show some typical SRM | V-Class loudspeaker setups, including some that involve a subwoofer.



This icon marks information that is critically important or unique! For your own good, read and remember them...it is a good idea to pay special attention to these areas in the Owner's Manual marked with the "VERY IMPORTANT" hand icon.



There's an illustration of a microscope, so, of course, you're going to get more detailed information when you see this little guy. There are explanations of features and practical tips listed here.



It's a good idea to pay attention to text displayed next to a note icon, as this icon draws attention to certain features and functions relating to the usage of the SRM | V-Class Series.

Please write the serial numbers here for future reference (i.e., insurance claims, tech support, return authorization, make dad proud, etc.)

Purchased at:

Date of purchase:

Getting Started

The following steps will help you set up the loudspeakers quickly.

1. Make all initial connections with the power switches OFF on all equipment. Make sure the master volume, level and gain controls are all the way down.
2. If not using a subwoofer, connect the outputs from the mixing console (or other signal source) to the inputs on the rear panel of the loudspeakers.
3. If using a subwoofer, connect the outputs from the mixing console (or other signal source) to the inputs on the subwoofer, then connect the high pass outputs from the subwoofer to the inputs of the loudspeakers.
4. Push the line cord securely into the subwoofer's / loudspeaker's IEC connectors and plug the other ends into grounded AC outlets. The subwoofer/loudspeaker may accept the appropriate voltage as indicated near the IEC connector.
5. Turn the mixer (or other signal source) on.
6. Turn the subwoofer on (if applicable).
7. Turn the loudspeakers on.
8. Make sure the loudspeaker's channel gain knob(s) are set to mic / Hi-Z or line followed by setting the channel levels to (or near) 0 dB. More information may be found on pages 11-13.
9. Start the signal source and raise the mixer's main L/R fader up to a comfortably loud listening level.

Things to Remember:

- Never listen to loud music for prolonged periods. Please see the Safety Instructions on page 2 for information on hearing protection.
- As a general guide, the mixer (or other signal source) should be turned on first, subwoofers next, and SRM | V-Class loudspeakers last. As such, the SRM | V-Class loudspeakers should also be turned off first, followed by the subwoofers, then the mixer. This will reduce the possibility of any turn-on or turn-off thumps and other noises generated by any upstream equipment from coming out of the speakers.
- Save the shipping boxes and packing materials! You may need them someday. Besides, the cats will love playing in them and jumping out at you unexpectedly. Remember to pretend like you are surprised!
- Save your sales receipt in a safe place.

Hookup Diagrams

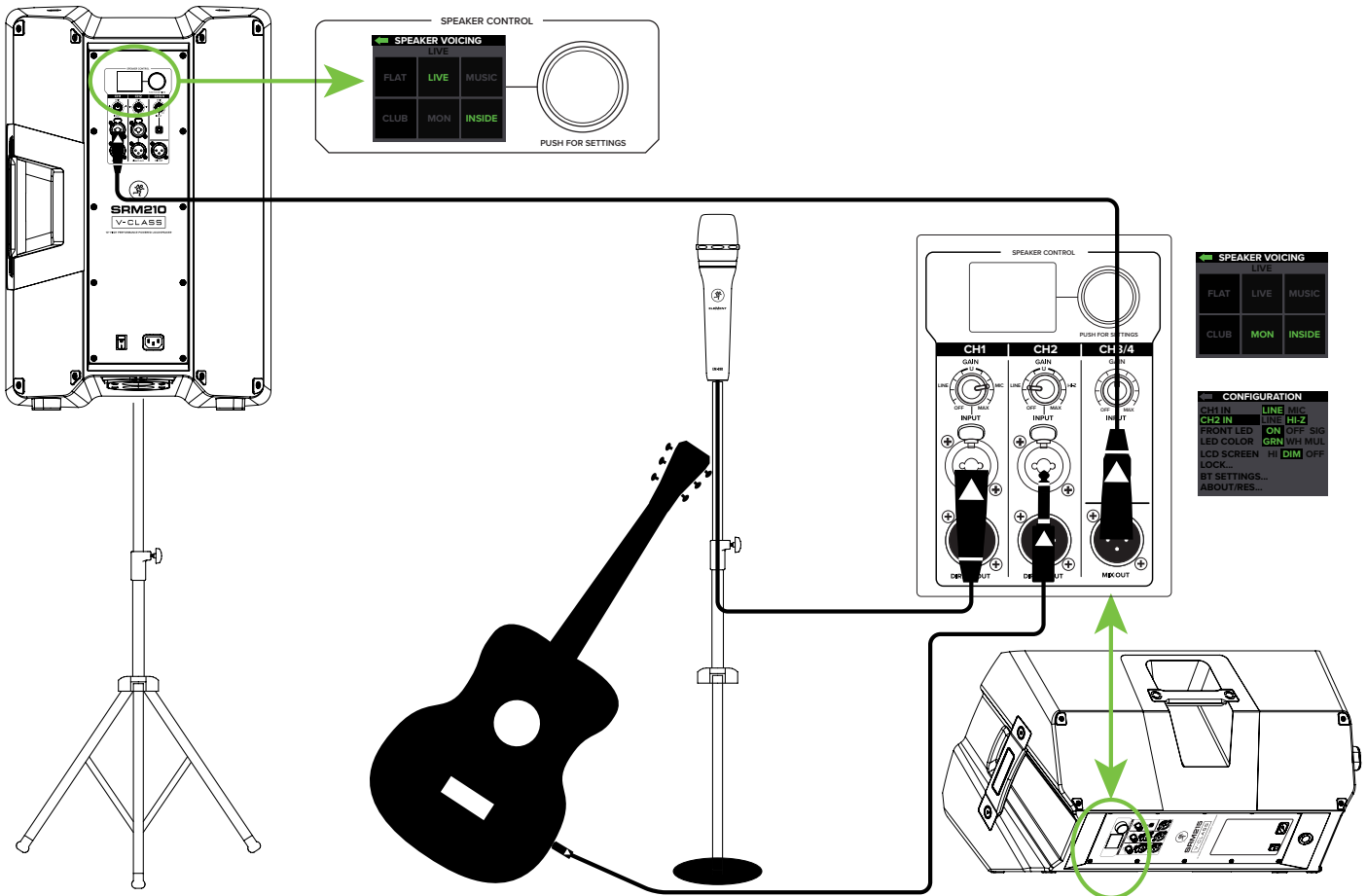

SRM | V-Class loudspeakers are the perfect tool for singer-songwriters touring the local coffee shops. Bring your favorite axe and mic, SRM | V-Class loudspeakers and cables and power cords.

In this example, a Mackie EM-89D dynamic microphone is connected to the channel 1 input of an SRM215 | V-Class loudspeaker, used for monitoring purposes. Note that the gain knob is set to Mic.

Now grab your axe and plug it directly into the channel 2 input. Or if you use effects, connect the guitar to the effects input and another cable from the effects output to the channel 2 input. Note that the gain knob is set to Line.

An SRM210 | V-Class loudspeaker will be used for the main PA. Simply connect a cable from the SRM215 | V-Class monitor's MIX OUT jack to the SRM210 | V-Class PA's channel 1 input.

For the output, you will want to set a speaker mode, described in detail on page 14. For this type of setup, Live works well for the main SRM210 | V-Class. Select the Monitor mode for the SRM215 | V-Class monitor. Additionally, you will want to set the monitor's configuration > channel 2 input to Hi-Z to account for the guitar.

Singer-Songwriter Setup

Hookup Diagrams continued...

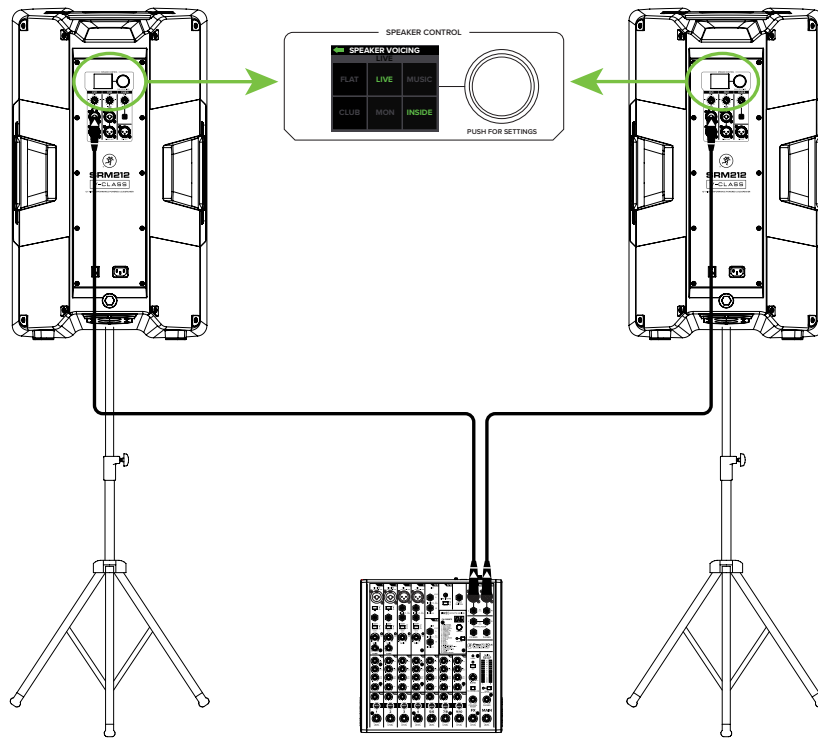

In this example, a ProFX10v3 mixer is connected directly to two SRM212 | V-Class loudspeakers. It is the perfect setup for a small club or... a fun karaoke house party! Simply connect the L/R outputs of the ProFX10v3 mixer to the channel 1 input of each SRM212 | V-Class loudspeaker. The gain knob on both should be set to Line. Don't forget to set the Speaker Mode on both loudspeakers to Live... or Club if you want a little more low-end thump!

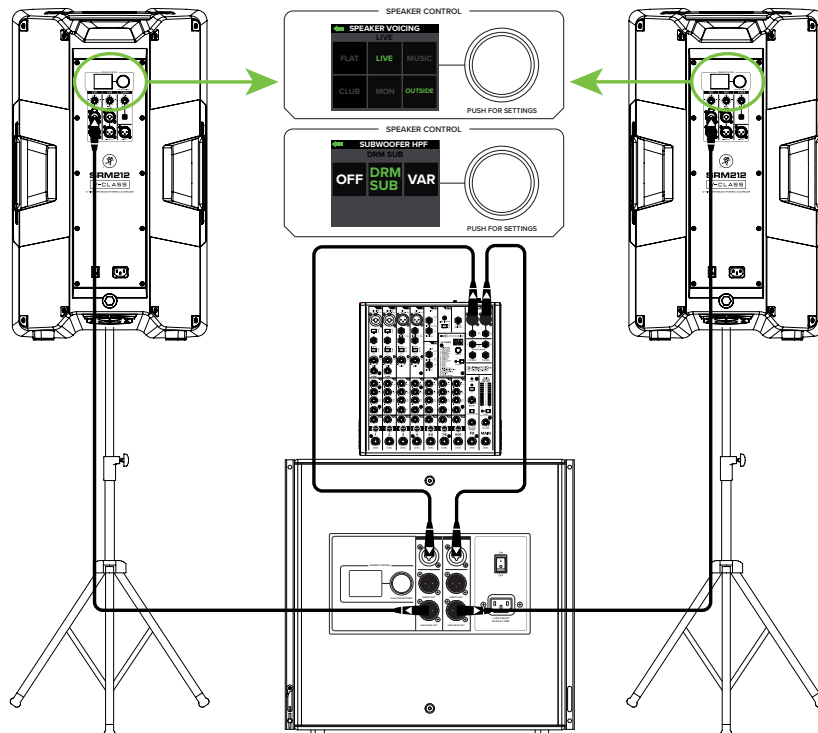

If you desire a little more boom, add a DRM18S subwoofer to the mix. Here, the L/R outputs of a ProFX10v3 mixer are connected directly to the channel 1 and 2 inputs of the DRM18S subwoofer. Then the High-Pass Outs of the subwoofer are connected to the channel 1 inputs of a pair of SRM212 | V-Class loudspeakers. The gain knob on both should be set to Line. Here you will want to set the Speaker Mode to either Live or Club and the Subwoofer HPF to DRM Sub (or Var if using a different subwoofer).

Small Club System

Hookup Diagrams continued...

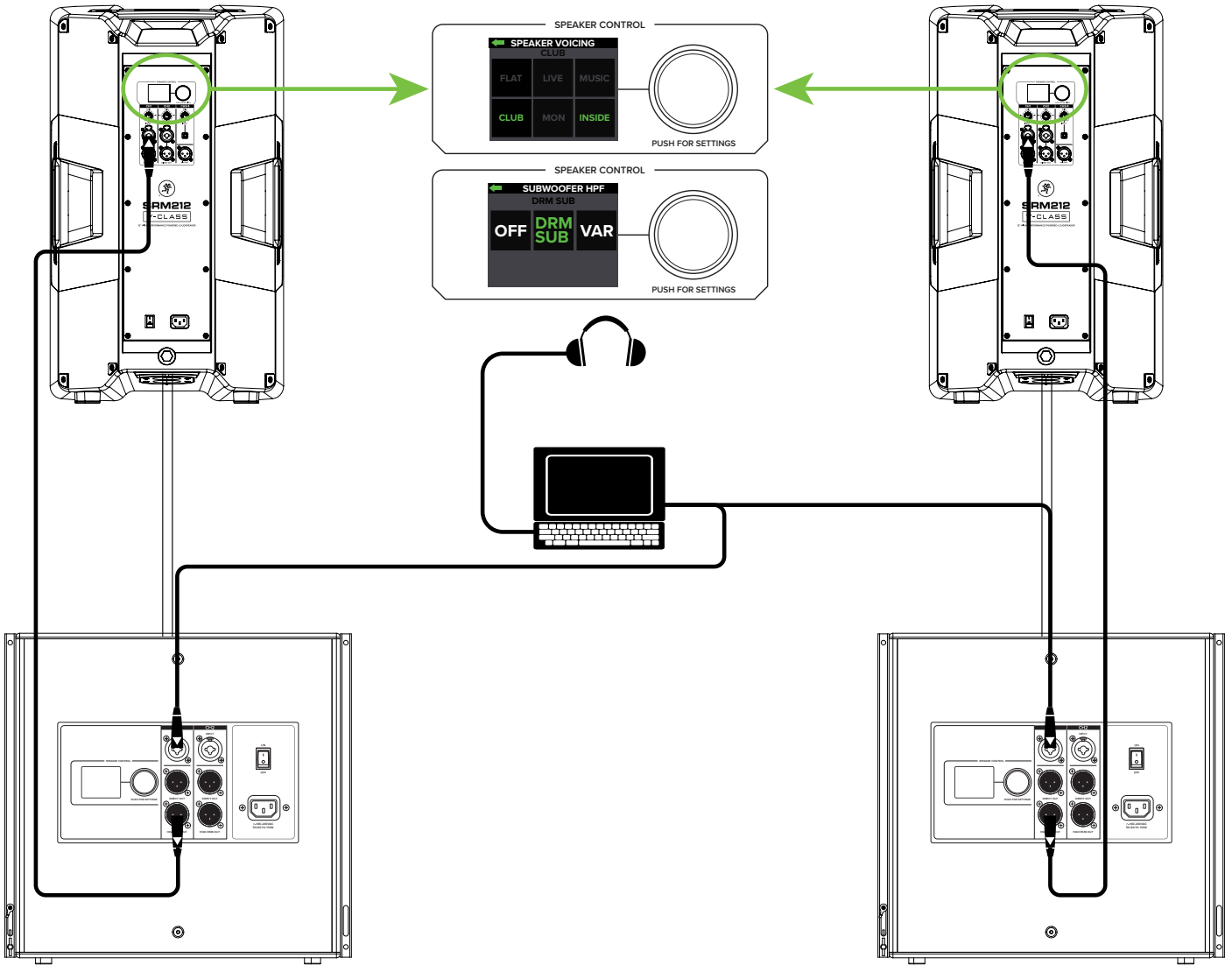

Perhaps you're a DJ playing bumpin' tunes in the middle of the night to a crowd that's groovin' and dancin' to your fine selection.

In this example, a laptop is connected to the inputs of two DRM18S subwoofers.

The High-Pass Out of each subwoofer is then connected to the input of each SRM212 | V-Class loudspeaker. Additionally, a set of Mackie MC-250 headphones is connected to the phones jack of the laptop.

The Speaker Modes of both loudspeakers may be set to Club and the Subwoofer HPF set to DRM Sub.

DJ System

Hookup Diagrams continued...

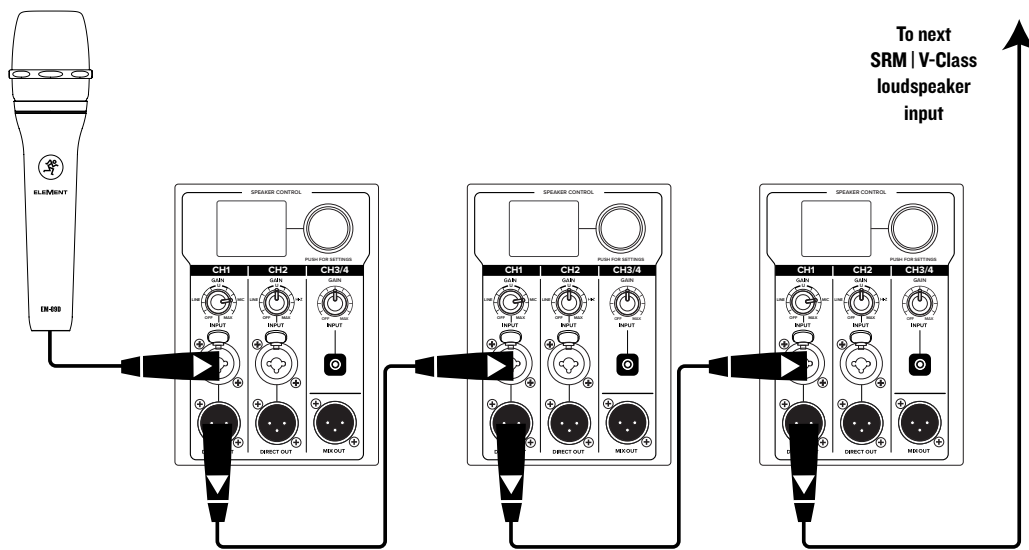
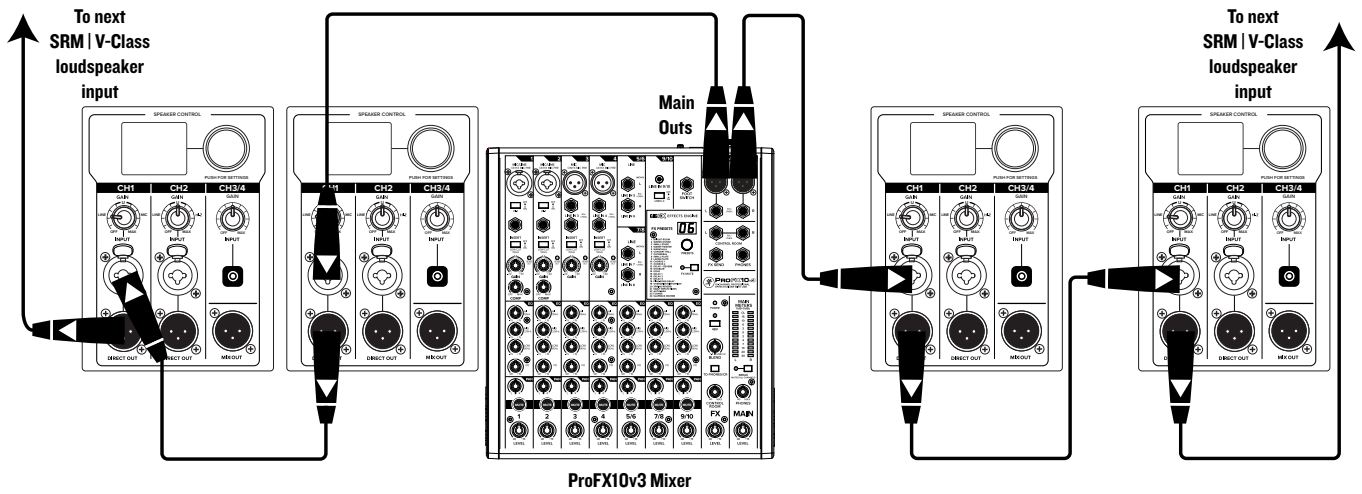

SRM | V-Class loudspeakers may be daisy-chained via the male XLR connector labeled “DIRECT OUT” (which sends only the signal from the input located above it) or via the “MIX OUT” which outputs all inputs. Simply plug the signal source (i.e., mixer output or microphone) into the input jack(s), and patch that loudspeaker’s direct out or mix out jack to the next loudspeaker’s input jack, and so on, daisy-chaining multiple SRM | V-Class loudspeakers. See above for visual representations of daisy-chaining.

NOTE: Make sure to set the gain knob(s) correctly. In the top diagram, input channel 1 is set to “LINE” and in the bottom diagram, input channel 1 is set to “MIC”.

Daisy-Chaining Multiple SRM | V-Class Loudspeakers

Hookup Diagrams continued...

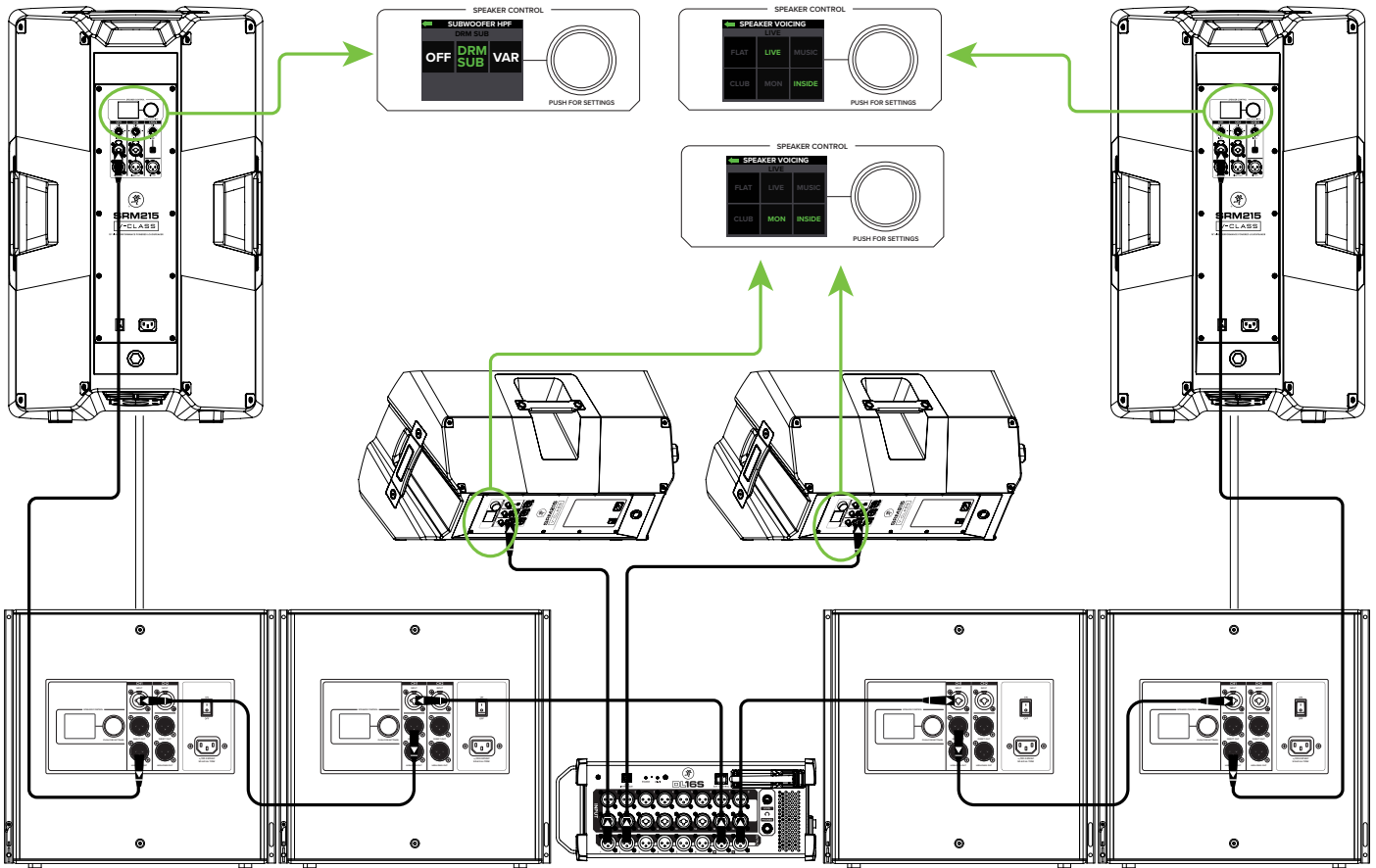

Here's how to set up a large club system. In this example, the L/R outputs of a DL16S mixer are connected directly to the channel 1 inputs of a pair of DRM18S subwoofers. The Direct Out of each subwoofer is then connected to the inputs of an additional pair of DRM18S subwoofers.

From here, the high-pass outputs of the two outer DRM18S subwoofers are connected directly to the inputs of a set of SRM215 | V-Class loudspeakers. The Speaker Modes of these PA loudspeakers may be set to Live (or Club) and the Subwoofer HPF set to DRM Sub. Talk about beefy low end!

Outputs 1 and 2 from the mixer may be used as aux sends; these are connected directly to the channel 1 inputs of a pair of SRM215 | V-Class loudspeakers to be used as monitors for the band. The gain knob on all SRM215 | V-Class loudspeakers in this example should be set to Line. The Speaker Modes of the monitor loudspeakers may be set to Monitor.

Large Club System

SRM | V-Class Loudspeakers: Rear Panel Features

SRM Connect App

SRM | V-Class loudspeakers are designed to be used in conjunction with the SRM Connect App. With it, all of the hardware features listed here – and more! – may be controlled remotely via Bluetooth connection. The only thing the SRM Connect App can't do is turn the loudspeaker on and off.

More information about the SRM Connect App may be found by visiting the SRM Connect App Reference Guide.

1. Power Connection

This is a standard 3-prong IEC power connector. Connect the detachable power cord (included in the packaging with the loudspeaker) to the power receptacle, and plug the other end of the power cord into an AC outlet.



Make sure that the AC power is matched to the AC power indicated on the rear panel (above the IEC receptacle).



Disconnecting the plug's ground pin is dangerous. Don't do it!

2. Power Switch

Press the top of this rocker switch inwards to turn on the loudspeaker. Press the bottom of this rocker switch inwards to turn off the loudspeaker.



As a general guide, the mixer (or other signal source) should be turned on first, subwoofers next, and loudspeakers last.

As such, the loudspeakers should also be turned off first, followed by the subwoofers, then the mixer. This will reduce the possibility of any turn-on or turn-off thumps and other noises generated by any upstream equipment from coming out of the speakers.

3. XLR and 1/4" Combo Inputs [Ch. 1 and 2]

Input channels 1 and 2 may accept a balanced mic signal using an XLR connector. They are wired as follows, according to standards specified by the AES (Audio Engineering Society).

XLR Balanced Wiring:

- Pin 1 = Shield (ground)
- Pin 2 = Positive (+ or hot)
- Pin 3 = Negative (- or cold)

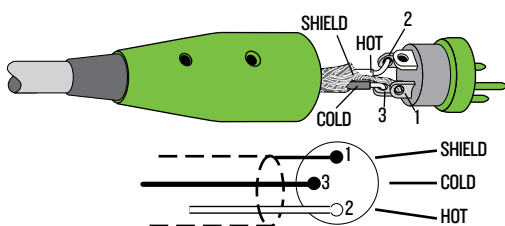

1/4" TRS Balanced Mono Wiring:

- Sleeve = Shield
- Tip = Hot (+)
- Ring = Cold (-)

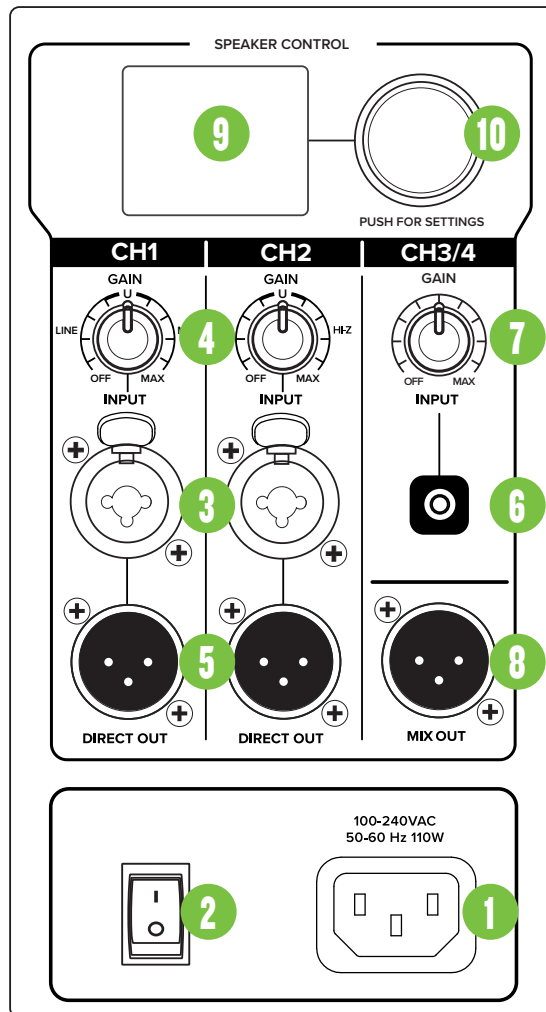
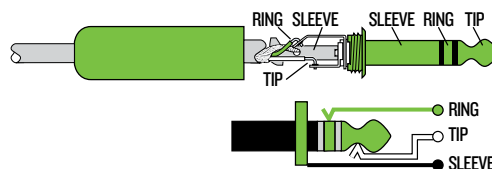

In addition to accepting a balanced mic signal using an XLR connector, these input channels may also accept 1/4" line-level signals driven by balanced or unbalanced sources.

Channel 2 may also accept a Hi-Z source (such as a guitar) via the 1/4" input without the need for a separate DI box. Be sure to set the Ch. 2 In to Hi-Z in the Configuration menu, though! Directions on page 18.

To connect balanced lines to these inputs, use a 1/4" Tip-Ring-Sleeve (TRS) plug. "TRS" stands for Tip-Ring-Sleeve, the three connection points available on a stereo 1/4" or balanced phone jack or plug. TRS jacks and plugs are used for balanced signals and are wired as follows:

SRM | V-Class Loudspeakers: Rear Panel Features continued...

To connect unbalanced lines to these inputs, use a 1/4" mono (TS) phone plug, wired as follows:

1/4" TS Unbalanced Mono Wiring:

Sleeve = Shield

Tip = Hot (+)

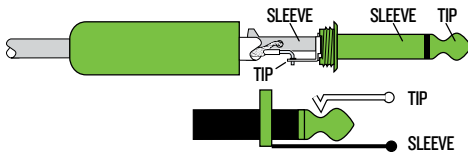

NEVER connect the output of an amplifier directly to an SRM | V-Class input jack. This could damage the input circuitry!

4. Gain [Ch. 1 and 2]

The gain knobs adjust the input sensitivity of the mic/line inputs. This allows signals from the outside world to be adjusted to run through each channel at optimal internal operating levels.

It ranges from off (knob fully down) up to max (knob fully up).



If connecting mixer outputs to loudspeaker inputs, set the gain knob to 10:00 ["LINE"] for optimal sound and performance.

5. Direct Out [Ch. 1 and 2]

This is a male XLR-type connector that produces exactly the same signal that is connected to the input jack located above it. Use it to daisy-chain several SRM | V-Class loudspeakers together off the same signal source(s).

They are wired as follows, according to standards specified by the AES (Audio Engineering Society):

Balanced XLR Output Connector

Pin 1 – Shield (ground)

Pin 2 – Positive (+ or hot)

Pin 3 – Negative (- or cold)

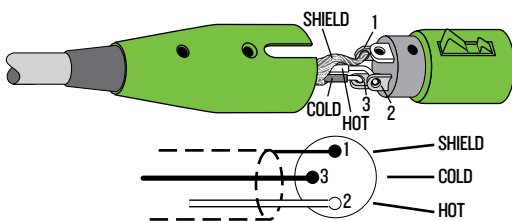

See page 8 to learn more about daisy-chaining SRM | V-Class loudspeakers.

6. 1/8" Input [Ch. 3/4]

This input may accept a stereo 1/8" line-level signal from a phone, tablet, MP3 player, or other signal source.



NEVER connect the output of an amplifier directly to an SRM | V-Class input jack. This could damage the input circuitry!

7. Gain [Ch. 3/4]

This gain knob adjusts the input sensitivity of the 1/8" stereo input. This allows signals from the outside world to be adjusted to run at optimal internal operating levels. It ranges from off (knob fully down) up to max (knob fully up).

8. Mix Out

This is a male XLR-type connector that produces the post-DSP mix – after voicing mode and EQ, but before the alignment delay – from all three input jacks (with Ch. 3/4 mono-summed). Use it to daisy-chain several SRM | V-Class loudspeakers together off the same signal source(s).

It is wired the same as the direct outputs as seen to the left.

9. LCD Display

This modern, high-resolution, all-color TFT LCD Display is one of the most vital features of the SRM | V-Class loudspeaker. It displays loudspeaker information including (but not limited to) levels, EQ, selected voicing, settings, lock / unlock status and other parameters.



The brightness is controllable (hi, dim, off), but it must be set to hi or dim for certain aspects of the set-up options.

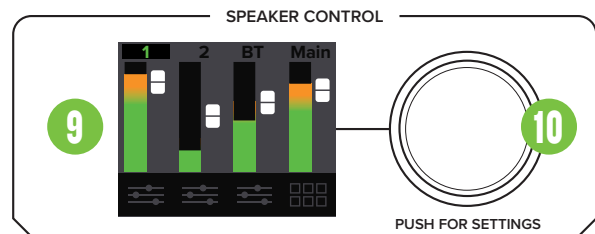

10. Speaker Control Knob

This push-button rotary encoder allows you to access functions such as channel and master level control and metering, application specific voicings & EQ, setup functions, product information and much more!

SRM Mix Control™

The following list provides the high level navigation items, in order, on the user interface and their subsequent user controlled parameters.

The default screen is the mixer view, as seen below:

Mixer – This displays the I/O levels and metering, EQ settings, HPF levels and more. These may all be changed here.

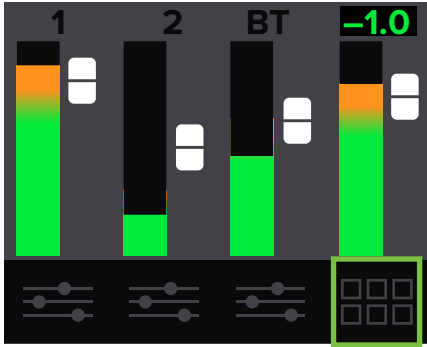

Menu – The menu provides icon selectors for all user-controllable functions with most of these containing an array of sub-menus.

The menu is accessed by rotating the speaker control knob clockwise until the menu icon is illuminated in a can't-miss DayGlo green; then press again to open the menu.

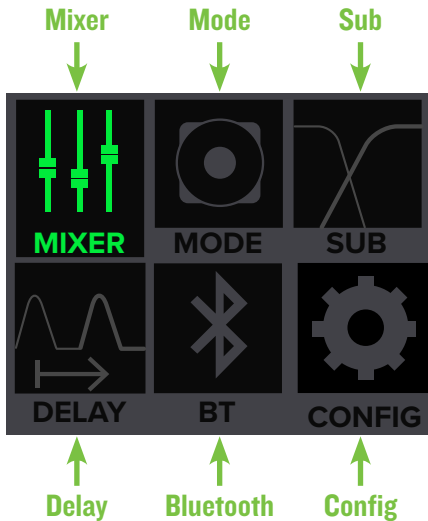

We will go through each, how to get there and how to change settings.

After a selection is made, the LCD screen will revert back to the Mixer screen after a short period of (speaker control) inactivity. You yourself may continue to be as active (or inactive) as you want.

Rotate the speaker control knob to navigate between the selections and push the button to open and edit the parameters.

Mixer

As mentioned earlier, the default screen is the mixer view. And the default selection is the output level. From here, simply rotate the speaker control knob clockwise (louder) or counter-clockwise (quieter).

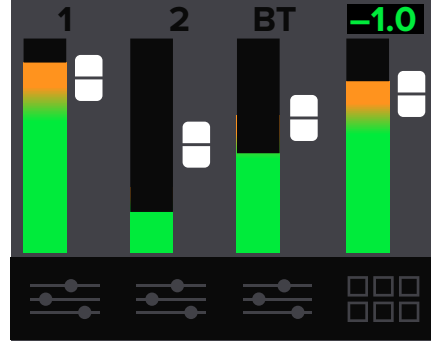

The top row selections change the levels of input channels 1, 2 and BT and the Main output. Notice below how each parameter illuminates as the speaker control knob is rotated to the right from channel 1 to 2, Bluetooth (BT) and the Main output last.

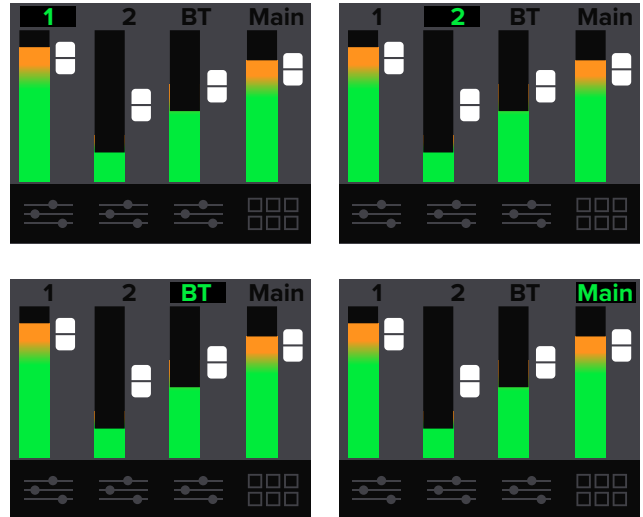

In order to change the level, push the speaker control knob when the desired channel is illuminated. In the example below, notice how the channel 2 fader has been moved to the -14 dB mark. Once the level you desire has been dialed in, press the speaker control knob again to return to the mixer screen.

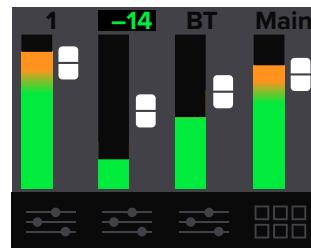

The level control ranges are as follows:

- Channels 1 and 2: $-\infty$ (off) to "U" (unity)
- Bluetooth: $-\infty$ (off) to "U" (unity)
- Main Output: $-\infty$ (off) to "U" (unity)



All four may also be muted (via the SRM Connect app). Red fader caps indicate a muted channel, while white fader caps indicate unmuted channels. A muted channel will unmute once a level is changed via the speaker control knob (or SRM Connect).

Let's expand on the meters for a moment. The peak holder meter peaks at +16 dBu and a 4:1 compressor engages at approximately +8 dBu. This means that the loudspeaker is compressing when the peak/hold indicator is hitting the top of the meter scale. It also signifies that you are nearing the end of available headroom. As you continue to raise the volume, you're continuing to compress the signal, as well. This is reflected in compression of the metering - which will remain at or near the top of the meter strip - and reflected in the acoustic output.

In addition to raising and lowering the input and output levels, the mixer view is where to adjust the EQ parameters and access the Menu screen, too. These icons are located underneath each meter.

In order to change a channel's EQ, push the speaker control knob when the desired channel's EQ icon is illuminated.

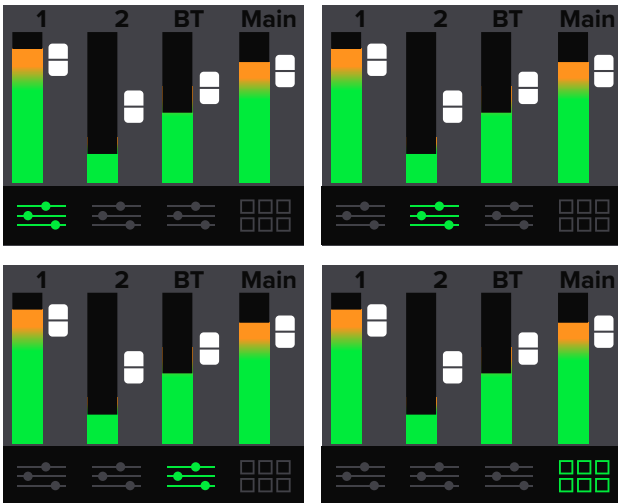

Next, push the speaker control knob again once the EQ you want to change is illuminated. See below.



The EQ ranges are as follows:

- High: ±12 dB @ 5 kHz
- Mid: ±12 dB @ 2.5 kHz
- Low: ±12 dB @ 80 Hz
- HPF: 80 Hz – 150 Hz @ 12 dB per octave [Channels 1 and 2 only]

As seen below, we changed the channel 1 high, mid and low EQ to +5 and the HPF setting to 110 Hz. Press the speaker control knob to return to the previous screen once the EQ settings you desire have been dialed in.



In addition to the four EQ choices shown above, there's a fifth and final selection: the left-facing arrow. Illuminating and selecting this simply returns you to the main mixer screen.

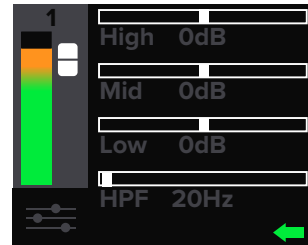

Other than the aforementioned EQ settings screen, this is also where to access the menu screen. From the mixer screen, simply rotate the speaker control knob right until the bottom right icon is illuminated (A). Then push the knob to enter the menu screen (B).

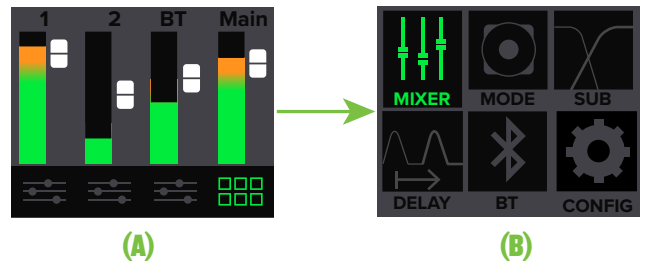

Let's take a look and see what the menu screen does. The first step is to flip the page!

Menu Screen

The menu screen displays six icons. Like the mixer screen, just rotate the speaker control knob until the icon of the parameter you want to change is illuminated. Then push the knob to enter that icon's screen.

The six icon selectors are as follows:

- Mixer
- Speaker Mode
- Sub
- Delay
- Bluetooth
- Configuration

We'll go through each one, starting with mixer at the top left.

Mixer

This is the easiest to describe since we just went through the mixer screen on the last two pages! To recap, though, the mixer screen is where to set levels and channel EQ.

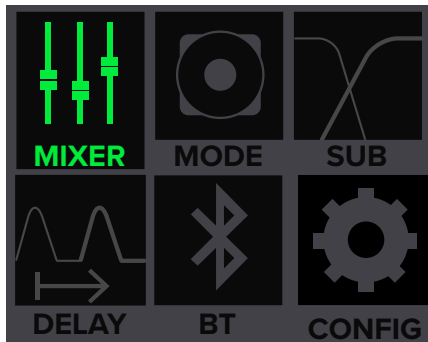

Speaker Mode

Speaker mode allows you to change the loudspeaker's speaker voicing to tailor it to best suit your particular application.

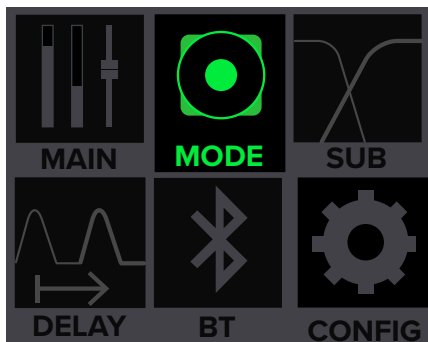

Once speaker mode is illuminated push in the speaker control knob to enter and update.

The view will look somewhat similar to this:

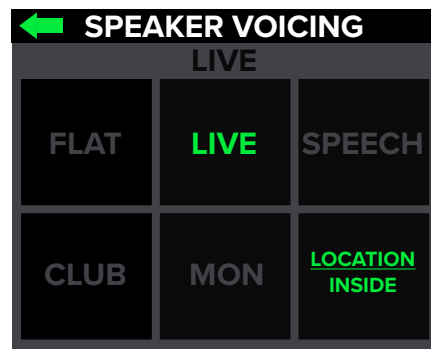

There are five speaker modes, plus an additional choice of inside or outside use. That is essentially TEN speaker voicing modes to choose from! Let's check them out:

- Flat – No question about this speaker mode; it's flat! This plug-and-play mode is perfect for singer-songwriters and listening to mastered music.

- Live – This mode features a low frequency roll-off to get rid of unwanted thumps and adds boost and sparkle to mid-range and high frequencies.

- Speech – This mode features a significant low frequency roll-off to get rid of unwanted thumps. It also adds boost and sparkle to mid-range and high frequencies, critical for speech applications. Lastly, a compressor has been added to help control spoken audio levels. This plug-and-play mode is perfect for larger venue applications where speech is the primary audio source in need of clear and precise intelligibility.

- Club – This mode is full range, but focuses on increased bass and brilliant high frequencies. This is the place to start for most DJ / music playback applications.

- Monitor – Monitor mode was designed primarily to remove unwanted low frequency buildup while also improving mid-range articulation for the artist(s).

NOTE This mode should only be engaged when the speaker is in its monitor orientation and coupled with a stage or other hardwood floor... if not, the speaker won't sound right.

About that inside / outside selection... in a sentence, choose whether you are using the loudspeaker inside or outside. The speaker's voicing is altered to the environment. That's all you need to know, but we're going to give you more!

When speakers are outside, a combination of low and high frequencies don't build up the way they do inside. SRM | V-Class corrects for that by boosting the frequency ranges that become deficient so the speaker sounds the same outside as when it's inside. You make the selection, we'll do the rest!

Simply rotate the speaker control knob until the speaker mode you desire is illuminated, then push to select it. As seen above, we selected Live Inside.

In addition to all of the speaker mode choices, there's a final selection: the left-facing arrow. Illuminating and selecting this simply returns you to the menu.

Refer to the Frequency Response graphs on pages 28 and 29 for further information.

Sub

After pushing the speaker control knob in to select sub, you will be presented with a multitude of choices, including:

- **Off** – Choose this if there is no subwoofer connected to the system. Here you are using SRM | V-Class loudspeakers only.
- **DRM Sub** – Choose this if a Mackie DRM18S subwoofer is connected to the system. The crossover point is set to 90 Hz to work in perfect harmony with the Mackie DRM18S Sub. This is what we hope you choose, thank you for your support!

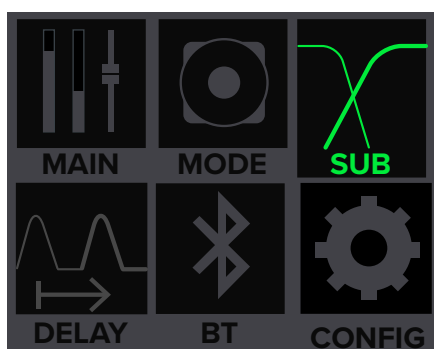

- **Var** – Choose this if a non-Mackie DRM18S subwoofer is connected to the system. Here you can select the subwoofer's HPF, ranging from 40 Hz – 160 Hz.

Rotate the speaker control knob until the sub HPF you desire is illuminated, then push to select it. If var is selected (as seen below), the frequency is illuminated and may be changed by rotating the speaker control knob clockwise (raise the frequency) and counter-clockwise (lower the frequency).

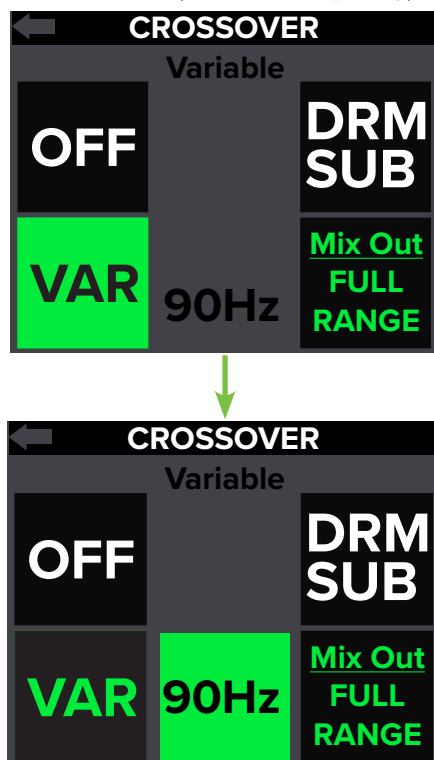

Also available is a mix out mode. The mix out mode allows you to select if the signal passes all frequencies (Full Range) or only the low frequencies (Low Pass) out of the mix out jack, acting as a fixed or variable system crossover for full range systems where the audio is routed first through the V-Class, and then to the sub. Push the speaker control knob in and release to switch between the two mix out mode selections. Release when the one you desire is illuminated, then leave it be.

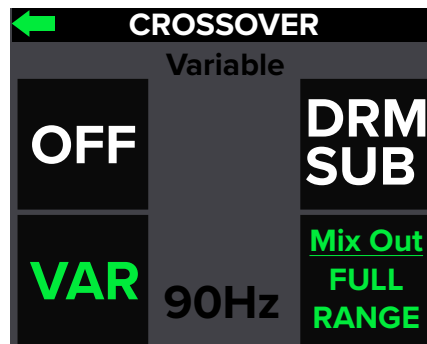

- **Full Range** – Selecting full range does not filter any frequencies, thereby sending the “full range” of frequencies, hence the name! This is typically preferred when connected to another loudspeaker.
- **Low Pass** – Selecting low pass essentially cuts out the high frequencies. This allows the subwoofer to do the majority of the “heavy lifting” on the lower frequencies, dependent on where the crossover is set. As such, this is typically selected when connected to a subwoofer.



Mix out mode is not available when the Subwoofer HPF is set to off.

In addition to the sub modes, there's a fourth and final selection: the left-facing arrow. Illuminating and selecting this simply returns you to the menu.

Delay

Probably the easiest parameter to describe and update. This controls the monitor delay. In other words, you are going to want to time-align the speakers throughout the venue so the sound hits everywhere simultaneously. This is the place.

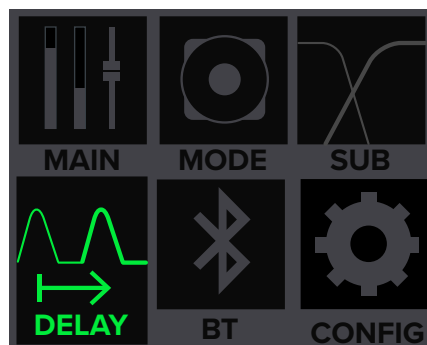

The delay time ranges from a low of 0.0 ms (ft, m) to a maximum of 100 ms (112.5 ft, 34.2 m).

In order to change the delay, first push the speaker control knob when the delay icon is illuminated (see image above). This opens the delay view.

From here, rotate the speaker control knob clockwise until the ms parameter is highlighted.



This is the only parameter that can be changed here; the ft and m delay time ranges update automatically dependent on where ms is set.

Push the speaker control knob in to select the ms parameter followed by rotating the speaker control knob clockwise (raise the delay time) and counter-clockwise (lower the delay time).

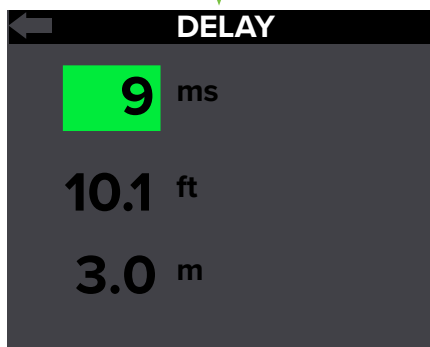
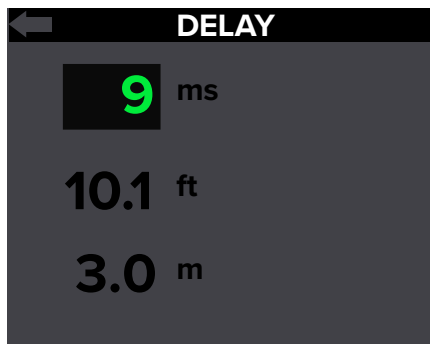

Like the previous sub-menus, the delay also has a left-facing arrow. Illuminating and selecting this simply returns you to the menu.

Bluetooth

This is where to set up and view wireless connectivity options for the devices and speakers.

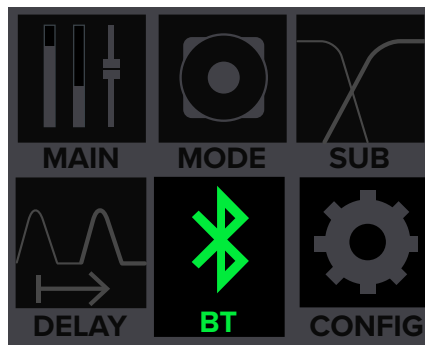

Below is a list of the parameters that may be edited:

Device – The device may either be paired or not paired.

To pair:

(1) Make sure “PAIR” is illuminated and push the speaker control knob.

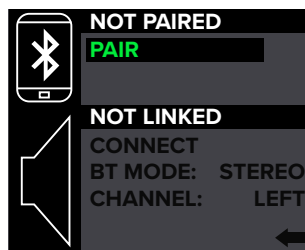

(2) The text “NOT PAIRED” will change to “DISCOVERABLE” and “PAIR” will change to “CANCEL”. From here, you can either (A) turn the device and device’s bluetooth on to pair, or (B) push the speaker control knob to cancel the action.

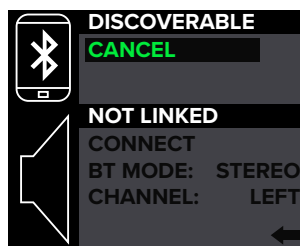

(3) The text “DISCOVERABLE” will change to “PAIRED” and “CANCEL” will change to “DISCONNECT”. From here, you can either (A) use the device and SRM Connect app to control the loudspeakers, or (B) push the speaker control knob to disconnect.

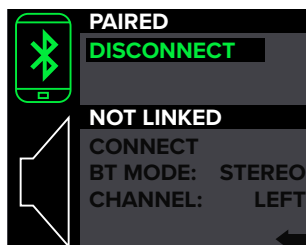

Notice how the icon of the device also illuminates when paired.

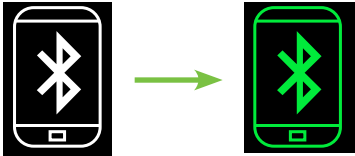

Notice how the icon of the loudspeaker also illuminates when linked.

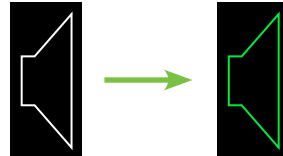

NOTE The Bluetooth connection may disconnect when affected by electrostatic discharge (ESD) or electrical fast transients (EFT). If this occurs, manually reconnect the Bluetooth connection.

SRM | V-Class Loudspeaker – The loudspeaker may either be linked or not linked. Additionally, this is where to select the bluetooth mode [zone or stereo]. Lastly, if the bluetooth mode is stereo, you may select which loudspeaker is located on the left and which is on the right.

To link:

The steps to link speakers is quite similar to that of pairing a device: (1) Make sure “connect” is illuminated and push the speaker control knob.

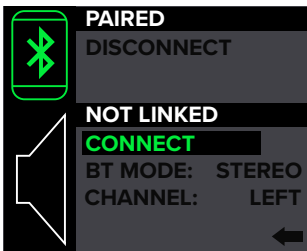

(2) The text “NOT LINKED” will change to “SEARCHING...” and “CONNECT” will change to “CANCEL”. From here, you can either (A) turn the other SRM | V-Class loudspeaker on and follow these same steps to link, or (B) push the speaker control knob to cancel the action.



(3) The text “SEARCHING...” will change to “PRIMARY” on one loudspeaker and “SECONDARY” on the other. Also, “CANCEL” will change to “DISCONNECT”. From here, you can either (A) select a Bluetooth mode (info to the right), or (B) push the speaker control knob to disconnect.

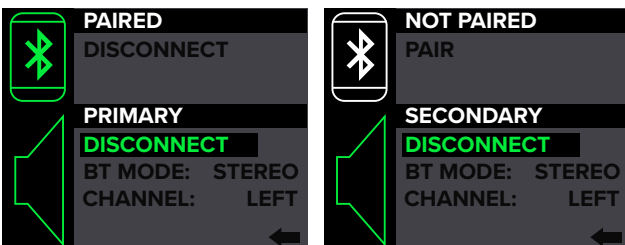

BT Mode – This is where to select the bluetooth mode [zone or stereo]. Rotate the speaker control knob until BT mode is illuminated then push it to switch between BT modes.

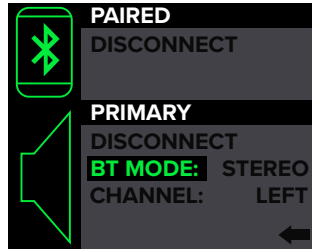

So what’s the difference? Let’s take a look!

STEREO: The stereo setting is your default two loudspeaker setup, ideal for applications such as a party, DJ, etc., where a device is paired and streaming music in stereo. Here the main level controls both speakers.

The following channels are available when the SRM | V-Class loudspeakers are linked in stereo:

- Ch. 1 Primary or Secondary
- Ch. 2 Primary or Secondary
- Bluetooth
- Stereo Main

If the bluetooth mode is set to stereo, you may select which loudspeaker is located on the left and which is on the right. Simply rotate the speaker control knob so that channel is illuminated, then push it to switch between left and right.

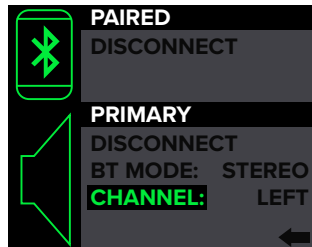

ZONE: The zone mode setting is your optional loudspeaker setup, ideal for when the speakers are placed in different locations and allows for separate main level controls.

SRM | V-Class loudspeakers in zone mode setting will receive a mono-summed signal.

The following channels are available when the SRM | V-Class loudspeakers are linked in zone mode:

- Ch. 1 Primary or Secondary
- Ch. 2 Primary or Secondary
- Bluetooth Primary or Secondary
- Primary or Secondary Main

As before, illuminating and selecting the left-facing arrow returns you to the previous screen.

Configuration

This is where to select the Ch. 1 and 2 input settings, front LED status and color, LCD brightness, lock access to the settings, auto connect / link bluetooth and more.

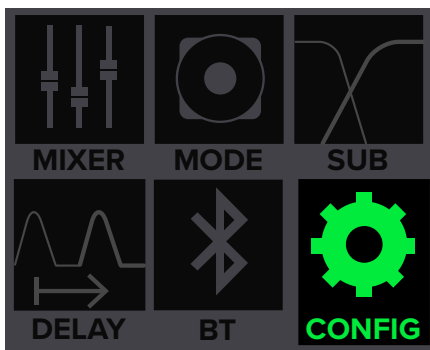

This is similar to what you will see after first entering the configuration screen. The current selection of the top five features will be illuminated.

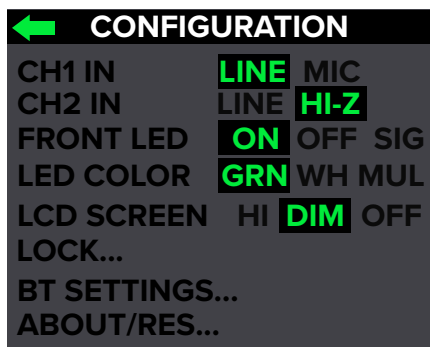

To change a setting, just rotate the speaker control knob until the configuration you desire to change is illuminated, then push to select it.

These are the choices from top to bottom:

Ch 1 in – As mentioned a few pages back, the channel 1 input accepts both XLR and 1/4" inputs. In addition to setting each channel's gain knob to the correct setting, be sure to set it here, as well. The selection will illuminate green; line on the left, mic on the right.

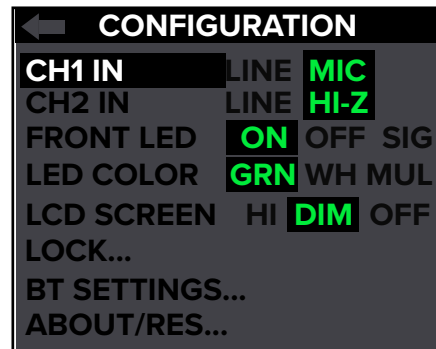

Illuminating and selecting the left-facing arrow returns you to the previous screen.



More information about the channel inputs may be found on pages 10-11.

Ch 2 in – In addition to the previously mentioned channel 1 input, the channel 2 input allows instruments to be connected directly into the 1/4" jack. To connect an instrument directly without using a DI Box, set channel 2's gain knob to Hi-Z and change the channel 2 input setting to Hi-Z. The Hi-Z text will illuminate to indicate that Hi-Z is active. Next connect the output from the instrument to the channel 2 1/4" input. The input impedance is optimized for direct connection and high-frequency fidelity is assured.

Guitars may sound dull and muddy without a DI box or if Hi-Z is not engaged. When not set at Hi-Z, the channel 2 1/4" input become a line input, as seen below.

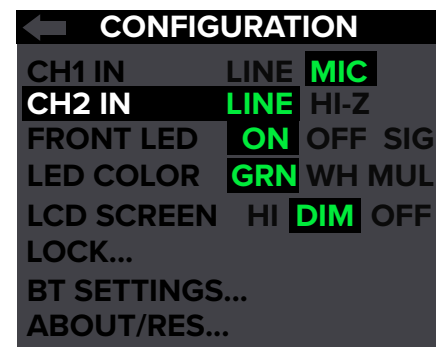

Illuminating and selecting the left-facing arrow returns you to the previous screen.



More information about the channel inputs may be found on pages 10-11.

Front LED Mode – There are two horizontal LED bars on the front of each SRM | V-Class loudspeaker. One bar is located near the bottom and the other near the top.

Here is where you decide if you want the front LED on, off or sig. When illuminated, push the speaker control knob to select between the three choices.

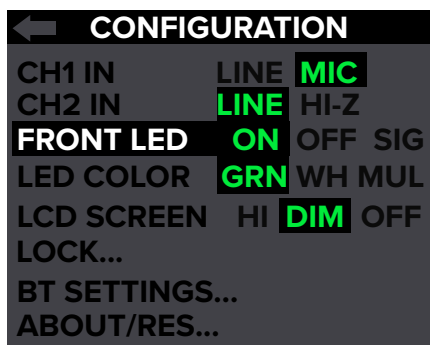

The three front LED modes are as follows:

- **On [Default]** – The LEDs illuminate in all their glory.
- **Signal** – The LEDs illuminate when there is signal at the outputs.
- **Off** – The LEDs do not illuminate; they are turned off and SRM | V-Class is in 'stealth' mode.

Like the previous sub-menus, configuration also has a left-facing arrow. Illuminating and selecting this simply returns you to the menu.

LED Color – Here is where you decide what color you want the front color LED. When illuminated, push the speaker control knob to select between the three choices.

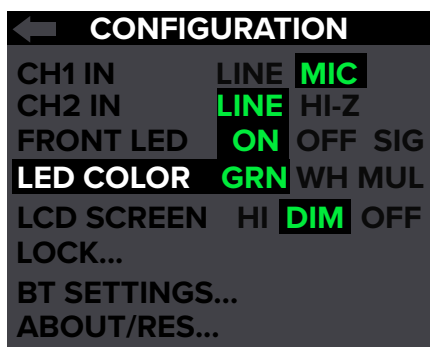

The three LED colors to choose from are:

- **Green [Default]** – The LEDs illuminate green.
- **White** – The LEDs illuminate... you guessed it. White!
- **Multi-color** – The LEDs switch between green, white and off in five second intervals. This is typically used in retail situations, but feel free to use it yourself!



Multi-color may only be selected if the front LED mode is set to on. It will not work if set to signal or off.

Illuminating and selecting the left-facing arrow returns you to the previous screen.

LCD Screen – The fifth configuration setting that may be changed is the brightness – or lack thereof – of the LCD screen.

There are three choices: hi, dim and off.

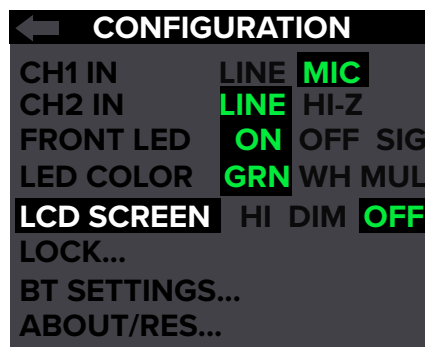

Hi or dim LCD screen brightness is required for certain aspects of the set-up options.

Illuminating and selecting the left-facing arrow returns you to the previous screen.

Lock... – This is where to lock and unlock the interface with a secret 4-digit numeric password.

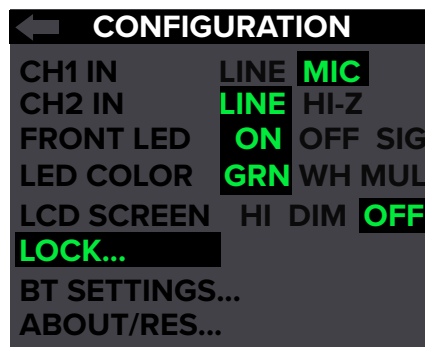

Locking – Push the speaker control knob to enter lock mode. From here, rotate the speaker control knob until the first number you desire is illuminated and press to select. Follow the same procedure for the next three numbers.

As seen below, we decided to go with 1-9-8-4 because we're "fans" of George Orwell. Notice how "lock" appears and is illuminated. Push the knob again to confirm the lock.

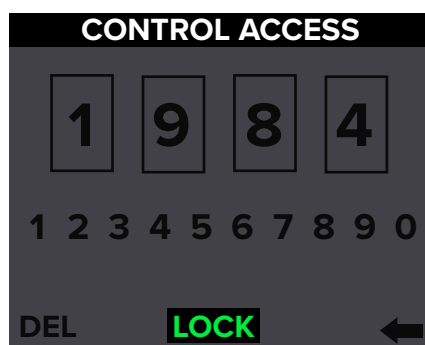

No further changes may be made until the control access is unlocked.

Unlocking – In order to unlock the loudspeaker, simply press the speaker control knob and you will be routed directly to the lock screen in the control access section. Here you will need to re-enter the 4-digit code and push the speaker control knob to unlock.

Secret Squirrel Unlock – If you – or worse, someone else! – set up a 4-digit lock code and you don't know the passcode, there is a quick fix. Simply press and hold down the speaker control knob down for a few seconds and it will automatically unlock.

Del, of course, deletes the previous selected number in case you made an oopsie. Speaking of oopsies, forget George Orwell, right?! We should have gone with Prince (1999) or Rush (2112) instead! Del is available whether locking or unlocking.

Illuminating and selecting the left-facing arrow returns you to the previous screen.

BT Settings – This is where the Bluetooth configuration settings (auto-connect, auto-link) live.

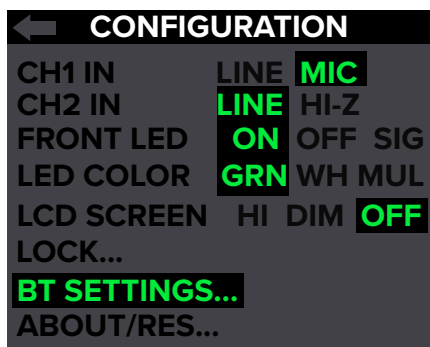

This is similar to what you will see after first entering the BT settings screen.

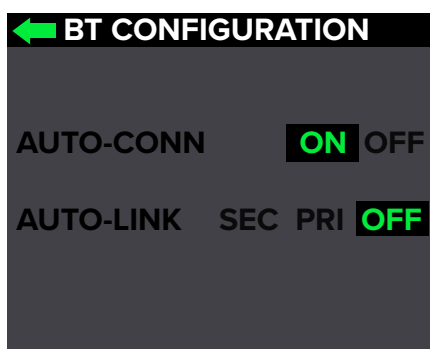

Auto Conn – Allows a previously paired device to auto reconnect if both the device and speaker are powered on and in range. When illuminated, push the speaker control knob to select between on or off.

Auto Link BT – Allows two previously paired speakers to automatically re-link if both are powered on and in range. When illuminated, push the speaker control knob to select between primary, secondary or off.

For obvious reasons, you cannot have two primary – or two secondary, for that matter – loudspeakers. Once a selection is made on one loudspeaker, the other loudspeaker will default to the other choice.



A Bluetooth-paired device may be connected to a primary or secondary loudspeaker. That said, we suggest pairing to the primary loudspeaker.

Illuminating and selecting the left-facing arrow returns you to the previous screen.

About/Res... – This displays the current information about your loudspeaker.

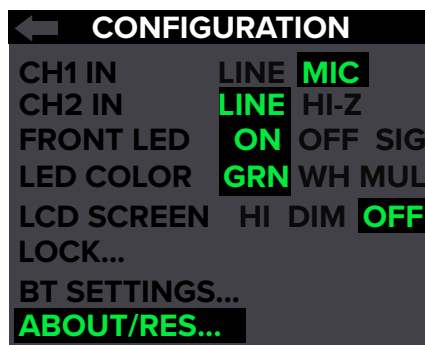

There are really only two reasons to ever go here:

- (1) If you've been instructed to do so by Technical Support; have this information handy!
- (2) If you need to do a factory reset on the loudspeaker.

This is similar to what you will see after first entering the About/Res settings screen.

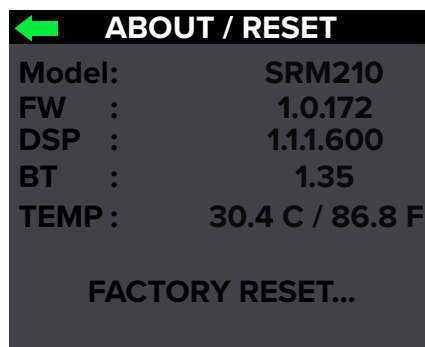

The first two items display the loudspeaker's firmware and DSP versions and the third is the temperature of the loudspeaker. None of these are editable, but they could come in handy if you need to talk to someone in Technical Support.

What may be selected here, though, is Factory Reset. As you might imagine, it restores all parameters back to their default. This is a permanent reset with no undo, so a confirmation dialog helps prevent accidents.

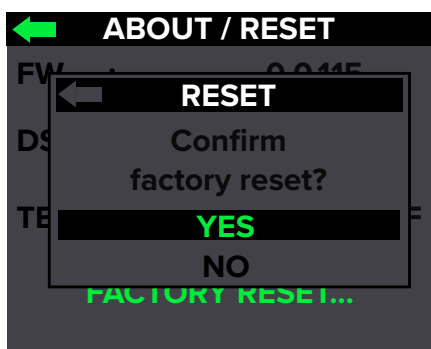

As we've discussed so many times before, illuminating and selecting the left-facing arrow returns you to the previous screen.



You should never ever ever EVER have to do this, but there is one more way to do a factory reset. We strongly recommend never doing this unless the loudspeaker is powered on and the LCD screen is nothing but black. If it comes to this, then turn the unit off. Push and hold the speaker control knob while turning the loudspeaker on. Release your finger from the knob after three seconds and let the loudspeaker "do its thing" for the next 30-60 seconds. Now turn the loudspeaker off and on again. It works!

Movie Night

We don't want to toot our own horn – but if we were, we would use an SRM | V-Class loudspeaker! – but we're not beyond patting ourselves on the back. Did you know that the LCD screen on the rear panel of the loudspeaker doubles as a movie screen?!

Beyond the Configuration setting is a seventh feature that may be selected: Movie Night! After pushing the speaker control knob in to select Movie Night, you will be presented with a wide selection of movies in a multitude of genres is available, including:



Once a genre is selected, a mountain of movie titles will be at your disposal, far too many to list here. Make a choice, grab a bucket of popcorn and enjoy the show!



Make sure the LCD screen brightness is set to high!

Protection Circuitry

SRM | V-Class loudspeakers employ a built-in limiter for less distortion at peak levels. A dynamic bass response circuit provides optimal low frequency response regardless of overall output level. Additional protection includes automatic thermal shutdown should the amp overheat. However, with Class-D amp technology, which is highly-efficient, this should never be a problem.



The protection circuits are designed to protect the loudspeakers under reasonable and sensible conditions. Should you choose to ignore the warning signs [e.g. excessive distortion], you can still damage the woofer in the loudspeaker by overdriving it past the point of amplifier clipping. Such damage is beyond the scope of the warranty.

Limiting

Let's take a peek under the hood at the polymer compression drivers. Compared to other available drivers, these provide a substantially smoother high-frequency response which results in a studio monitor level of accuracy and clarity. Furthermore, these drivers offer an insanely smooth transient response behavior. Yes, we, too, are fans of our own products!

Continuing on, the driver has its own compression circuit which helps protect it from damaging transient peaks. The compressor is designed to be transparent and is not noticeable under normal operating conditions.

Overexcursion Protection

A subsonic filter circuit just prior to the power amplifier prevents ultra-low frequencies from being amplified. Excessive low-frequency energy can damage the woofer by causing it to “bottom out,” also know as overexcursion, which is equivalent to a mechanical form of clipping.

Thermal Protection

All amplifiers produce heat. SRM | V-Class loudspeakers are designed to be efficient both electrically and thermally. In the unlikely event of the amplifier overheating, a built-in thermal switch will activate, muting the signal.

When the amplifier has cooled down to a safe operating temperature, the thermal switch resets itself, and the SRM | V-Class loudspeaker resumes normal operation.

If the thermal switch activates, try turning down the level control a notch or two on the mixing console (or via the Speaker Control knob) to avoid overheating the amplifier. Be aware that direct sunlight and/or hot stage lights may be the culprit of an amplifier overheating.

AC Power

Be sure the SRM | V-Class loudspeaker is plugged into an outlet that is able to supply the correct voltage specified for your model. It will continue to operate at lower voltages, but will not reach full power. Be sure the electrical service can supply enough amperage for all the components connected to it.

We recommend that a stiff (robust) supply of AC power be used because the amplifiers place high current demands on the AC line. The more power that is available on the line, the louder the speakers will play and the more peak output power will be available for a cleaner, punchier bass. A suspected problem of “poor bass performance” is often caused by a weak AC supply to the amplifiers.



Never remove the ground pin on the power cord or any other component of the SRM | V-Class loudspeaker. This is very dangerous.

Care and Maintenance

Your SRM | V-Class loudspeakers will provide many years of reliable service if you follow these guidelines:

- Avoid exposing the loudspeakers to moisture. If they are set up outdoors, be sure they are under cover if rain is expected.
- Avoid exposure to extreme cold (below freezing temperatures). If you must operate the loudspeakers in a cold environment, warm up the voice coils slowly by sending a low-level signal through them for about 15 minutes prior to high-power operation.
- Use a dry cloth to clean the cabinets. Only do this when the power is turned off. Avoid getting moisture into any of the openings of the cabinet, particularly where the drivers are located.

Placement



WARNING: Installation should only be done by an experienced technician. Improper installation may result in damage to the equipment, injury or death. Make sure that the loudspeaker is installed in a stable and secure way in order to avoid any conditions that may be dangerous for persons or structures.

SRM | V-Class loudspeakers are designed to sit on the floor or stage as the main PA or as monitors. They may also be pole-mounted via the built-in socket on the bottom of the cabinet. Be sure the pole is capable of supporting the weight of the loudspeaker. The T100 is a great tripod option and the SPM400 is a nice choice when using a subwoofer.

These loudspeakers may also be flown via their integrated fly points as detailed on the following pages. Be sure to read the PA-A3 Eyebolt Installation Instructions, as well.



NEVER attempt to suspend a SRM | V-Class loudspeaker by its handles.

Check to make sure that the support surface (e.g. floor, etc.) has the necessary mechanical characteristics to support the weight of the loudspeaker(s).

When pole-mounting loudspeakers, be sure that they are stabilized and secured from falling over or being accidentally pushed over. Failure to follow these precautions may result in damage to the equipment, personal injury, or death.

SRM | V-Class loudspeakers have dual angle pole-mounts for optimal coverage. The rear one is a straight angle while the front is angled at a 7° downward tilt. Additionally, SRM | V-Class loudspeakers may be laid out horizontally as monitors for the band at a 45° angle (as seen below). It is intended to be used only when the speaker is in its wedge configuration and works best when on a hard work surface, like a stage.

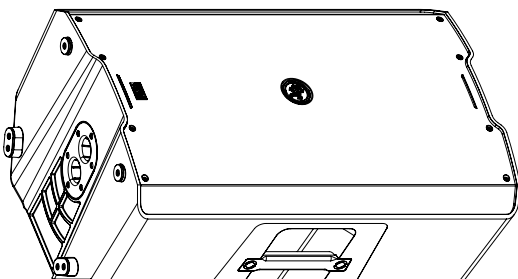

As seen above, the Running Man logo is rotatable for when the loudspeaker is used as a monitor!

As with any powered components, protect them from moisture. Avoid installing the loudspeaker in places exposed to harsh weather conditions. If you are setting them up outdoors, make sure they are under cover if you expect rain.

Room Acoustics

SRM | V-Class loudspeakers are designed to sound fantastic in nearly every application.

But, room acoustics play a crucial role in the overall performance of a sound system. However, the wide high-frequency dispersion of the SRM | V-Class loudspeakers helps to minimize the problems that typically arise.

Here are some additional placement tips to help overcome some typical room problems that might arise:

- Placing loudspeakers in the corners of a room increases the low frequency output and can cause the sound to be muddy and indistinct.
- Placing loudspeakers against a wall increases the low frequency output, though not as much as corner placement. However, this is a good way to reinforce the low frequencies, if so desired.
- Avoid placing the speakers directly on a hollow stage floor. A hollow stage can resonate at certain frequencies, causing peaks and dips in the frequency response of the room. It is better to place them on a sturdy stand designed to handle the weight of the loudspeaker.
- Position the loudspeakers so the high-frequency drivers are two to four feet above ear level for the audience (making allowances for an audience that may be standing/dancing in the aisles). High frequencies are highly directional and tend to be absorbed much easier than lower frequencies. By providing direct line-of-sight from the loudspeakers to the audience, you increase the overall brightness and intelligibility of the sound system.
- Highly reverberant rooms, like many gymnasiums and auditoriums, are a nightmare for sound system intelligibility. Multiple reflections off the hard walls, ceiling, and floor play havoc with the sound. Depending on the situation, you may be able to take some steps to minimize the reflections, such as putting carpeting on the floors, closing draperies to cover large glass windows, or hanging tapestries or other materials on the walls to absorb some of the sound.

However, in most cases, these remedies are not possible or practical. So what do you do? Making the sound system louder generally doesn't work because the reflections become louder, too. The best approach is to provide as much direct sound coverage to the audience as possible. The farther away you are from the speaker, the more prominent will be the reflected sound.

Use more speakers strategically placed so they are closer to the back of the audience. If the distance between the front and back speakers is more than about 100 feet, you should use either (1) the internal delay processor via the speaker control knob (see page 15), or (2) use an external delay processor to time-align the sound. (Since sound travels about 1 foot per millisecond, it takes about 1/10 of a second to travel 100 feet.)

Keep in mind that the speaker mode is another great way to compensate for some of these issues. See page 14 for more information.

Rigging



WARNING: Installation should only be done by an experienced technician. Improper installation may result in damage to the equipment, injury or death. Make sure that the loudspeaker is installed in a stable and secure way in order to avoid any conditions that may be dangerous for persons or structures.



WARNING: The cabinet is suitable for rigging via its fly points. NEVER attempt to suspend a SRM | V-Class loudspeaker by its handle.

The fly points are shown below, while an example of a flown SRM215 | V-Class is displayed below-right.



SRM | V-Class loudspeakers may only be flown vertically.

Rigging Design Practices

Rigging a loudspeaker requires determining:

1. The rigging methods and hardware that meet static, shock, dynamic, and any other load requirements for supporting the loudspeaker from structure.

2. The design factor and required WLL (Working Load Limit) for this support.

We strongly recommend the following rigging practices:

1. Documentation: Thoroughly document the design with detailed drawings and parts lists.

2. Analysis: Have a qualified professional, such as a licensed Professional Engineer, review and approve the design before its implementation.

3. Installation: Have a qualified professional rigger do the installation and inspection.

4. Safety: Use adequate safety precautions and back-up systems.

SRM | V-Class Fly Points

MP = Mounting Point

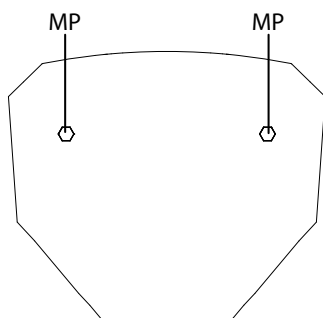

TOP

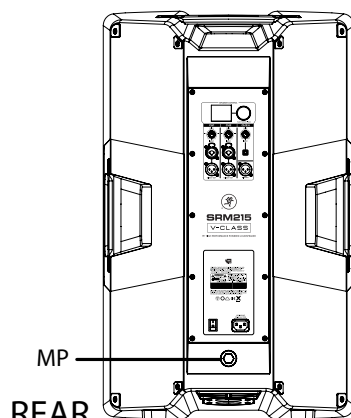

REAR

Rigging Hardware and Accessories

Rigging our loudspeakers will invariably require hardware not supplied by us. Various types of load-rated hardware are available from a variety of third-party sources. There are a number of such companies specializing in manufacturing hardware for designing and installing rigging systems. Each one of these tasks is a discipline in its own right. Because of the hazardous nature of rigging work and the potential liability, engage companies that specialize in these disciplines to do the work required.

We do offer certain accessory rigging items and some of them may be used with a variety of products. While these accessories are intended to facilitate installation, the wide variety of possible installation conditions and array configurations do not permit us to determine their suitability or load rating for any particular application.

We are not in the business of providing complete rigging systems, either as designers, manufacturers, or installers. It is the responsibility of the installer to provide a properly engineered, load-certified rigging system for supporting the loudspeaker from structure.



SRM | V-Class loudspeakers may be individually flown using a PA-A3 Eyebolt Kit, part number 2036960.

Rigging Notes

The SRM | V-Class loudspeaker's integral mounting points are designed to support only the weight of their own loudspeaker with suitable, external hardware. This means that each SRM | V-Class loudspeaker must be supported independently of any other SRM | V-Class loudspeaker and any other loads. At least the top two rigging points must be used to hang each SRM | V-Class loudspeaker. The bottom one helps with an even vertical hang or pullback for a down-tilt angle on the SRM212 and SRM215; there is no bottom rigging point on the SRM210.

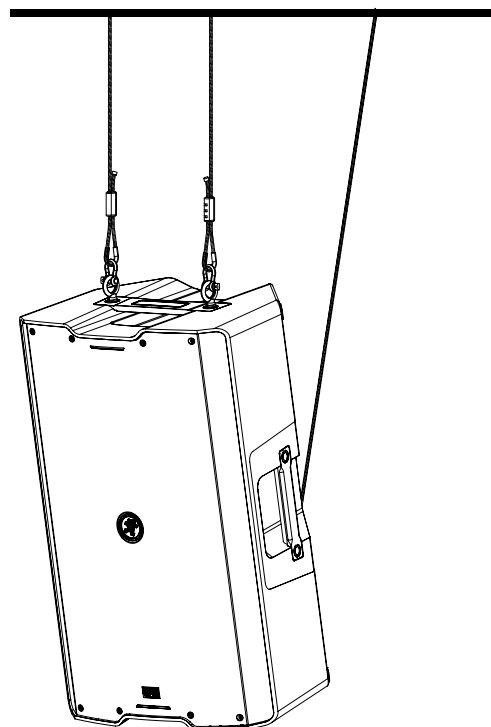

Appendix A: Service Information

If you think your SRM | V-Class loudspeaker has a problem, please check out the following troubleshooting tips and do your best to confirm the problem. Visit the Support section of our website (www.mackie.com/support) where you will find lots of useful information such as FAQs and other documentation. You may find the answer to the problem without having to part with your loudspeaker.

Troubleshooting

No power

- Our favorite question: Is it plugged in? Make sure the AC outlet is live [check with a tester or lamp].
- Our next favorite question: Is the power switch on? If not, try turning it on.
- Make sure the line cord is securely seated in the line cord socket and plugged all the way into the AC outlet.
- Is the power LED on the front panel illuminated? If not, make sure the AC outlet is live. If so, refer to “No sound” below.
- The internal AC line fuse may be blown. This is not a user serviceable part. If you suspect the AC line fuse is blown, please see the “Repair” section next.

No sound

- Is the level knob for the input source turned all the way down? Verify that all the volume controls in the system are properly adjusted. Look at the level meter to ensure that the mixer is receiving a signal.
- Is the signal source working? Make sure the connecting cables are in good repair and securely connected at both ends. Make sure the output level control on the mixing console is turned up sufficiently to drive the inputs of the speaker.
- Make sure the mixer does not have a mute on or a processor loop engaged. If you find something like this, make sure the level is turned down before disengaging the offending switch.
- Has it shut down? Make sure there is at least six inches of free space behind each SRM loudspeaker.

Poor sound

- Is it loud and distorted? Make sure that you're not overdriving a stage in the signal chain. Verify that all level controls are set properly.
- Is the input connector plugged completely into the jack? Be sure all connections are secure.

Noise

- Make sure all connections to the loudspeakers are good and sound.
- Make sure none of the signal cables are routed near AC cables, power transformers, or other EMI-inducing devices.
- Is there a light dimmer or other SCR-based device on the same AC circuit as the SRM | V-Class loudspeaker? Use an AC line filter or plug the loudspeaker into a different AC circuit.

Hum

- Try disconnecting the cable connected to the input jack. If the noise disappears, it could be a “ground loop,” rather than a problem with the SRM | V-Class loudspeaker. Try some of the following troubleshooting ideas:
 - Use balanced connections throughout your system for the best noise rejection.
 - Whenever possible, plug all the audio equipment's line cords into outlets which share a common ground. The distance between the outlets and the common ground should be as short as possible.

Other Issues

- Please email or call Technical Support if you are having any other issue not listed here:
 - o mackie.com/support-contact
 - o 1-800-898-3211

Repair

For warranty service, refer to the warranty information on page 34.

Non-warranty service is available at a factory-authorized service center. To locate the nearest service center, visit www.mackie.com/support/service-locator. Service for SRM | V-Class loudspeakers living outside the United States may be obtained through local dealers or distributors.

If you do not have access to our website, please call our Tech Support department at 1-800-898-3211 (normal business hours, Pacific Time), to explain the problem. They will tell you where the nearest factory-authorized service center is located in your area.

Appendix B: Technical Information

SRM V-Class Loudspeakers Specifications

Acoustic Performance

Frequency Range (-10 dB)	45 Hz - 20 kHz [SRM210]
	42 Hz - 20 kHz [SRM212]
	40 Hz - 20 kHz [SRM215]
Frequency Range (-3 dB)	55 Hz - 20 kHz [SRM210]
	50 Hz - 20 kHz [SRM212]
	44 Hz - 20 kHz [SRM215]
Horizontal Coverage Angle	90°
Vertical Coverage Angle	60°
Maximum SPL Peak	131 dB [SRM210]
	135 dB [SRM212]
	136 dB [SRM215]
Monitor Angle	45°

Transducers

Low Frequency	10 in / 254 mm [SRM210]
	12 in / 305 mm [SRM212]
	15 in / 381 mm [SRM215] with ferrite
High Frequency	1.4 in / 36 mm polymer compression driver

Power Amplifiers

System Power Amplification	
Rated Power	2000 watts peak
Low Frequency Power Amplifier	
Rated Power	1800 watts peak
Rated THD	< 1%
Cooling	Convection
Design	Class D
High Frequency Power Amplifier	
Rated Power	200 watts peak
Rated THD	< 1%
Cooling	Convection
Design	Class D

System Processing

Voicing	10 speaker modes [5 inside, 5 outside]
Subwoofer HPF	Off, DRM18S, Var
Input EQ	3-band
Delay	0 - 100 ms

Equalization

Low	±12 dB @ 80 Hz
Mid	±12 dB @ 2.5 kHz
High	±12 dB @ 5 kHz
HPF	20 Hz - 150 Hz (Var)

Input/Output

Input Type	2x Female XLR Balanced • 1/4" Balanced • 1/8" Stereo
Mic-Line Impedance	20 kΩ balanced
1/4" TS, Wide-Z™ Impedance	100 kΩ balanced
Direct Out and Mix Out	Male XLR Balanced
Mix Out Impedance	300 Ω balanced
Main Control	Rotating knob

Electronic Crossover

Crossover Type	24 dB/octave
Crossover Frequency	2.0 kHz

Line Input Power

Detachable line cord	~100 - 240 VAC, 50 - 60 Hz, 110W
	~220 - 240 VAC, 50 - 60 Hz, 110W
AC Connector	3-pin IEC 250 VAC, 10 A male
Power Supply Type	Switchmode

Safety Features

Input Protection	Peak and RMS limiting, power supply and amplifier thermal protection, overcurrent, over-voltage, dynamic thermal protections and forced air-cooling
Display LEDs	Defeatable front power, Speaker Control
Status Info	Input and output levels, voicing mode, sub HPF, EQ and delay settings

SRM V-Class Loudspeakers Specifications Continued...

Construction Features

Basic Design	Asymmetrical
Enclosure Material	Black Polypropylene
Enclosure Finish	Light Black Texture
Grille Material	16-18 gauge perforated steel w/nylon net backing
Grille Finish	Powder-coated black
Handles	One [SRM210], two on each side and one partial on top [SRM212 and SRM215]
Display LEDs	
Front	Power / Signal
Rear	Speaker Control
Operating Temperature	0 – 40 °C 32 – 104 °F

Physical Properties

SRM210:

Height:	23.0 in / 584 mm
Width:	15.1 in / 384 mm
Depth:	12.9 in / 328 mm
Weight:	30.9 lb / 14.0 kg

SRM212:

Height:	25.9 in / 658 mm
Width:	15.2 in / 386 mm
Depth:	14.2 in / 361 mm
Weight:	40.6 lb / 18.4 kg

SRM215:

Height:	28.8 in / 732 mm
Width:	17.6 in / 447 mm
Depth:	15.4 in / 391 mm
Weight:	48.9 lb / 22.2 kg

Mounting Methods:

Floor mount, pole mount via the built-in socket on the bottom of the cabinet [Be sure the pole is capable of supporting the weight of the SRM | V-Class loudspeaker] or fly via the integrated M10 mounting points (using M10 x 1.5 x 20 mm forged shoulder eyebolts).

See pages 23–24 for more information.

Options

SRM210 Cover	P/N 2036809-54
SRM212 Cover	P/N 2036809-55
SRM215 Cover	P/N 2036809-56
SRM210 Rolling Bag	P/N 2036809-57
SRM212 Rolling Bag	P/N 2036809-58
SRM215 Rolling Bag	P/N 2036809-59
T100 Loudspeaker Tripod Stand	P/N 2052464
SPM400 Loudspeaker Pole Mount	P/N 2051055
PA-A3 Eyebolt Kit	P/N 2036960

Disclaimer

Since we are always striving to make our products better by incorporating new and improved materials, components, and manufacturing methods, we reserve the right to change these specifications at any time without notice.

The “Running Man” figure is a registered trademark of LOUD Audio, LLC.

All other brand names mentioned are trademarks or registered trademarks of their respective holders, and are hereby acknowledged.

©2023 LOUD Audio, LLC. All Rights Reserved.

SRM | V-Class Loudspeakers Frequency Response Legend

FLAT Voicing Mode – No question about this speaker mode; it's flat! This plug-and-play mode is perfect for singer-songwriters and listening to mastered music.

LIVE Voicing Mode – This mode features a low frequency roll-off to get rid of unwanted thumps and adds boost and sparkle to mid-range and high frequencies.

SPEECH Voicing Mode – This mode features a significant low frequency roll-off to get rid of unwanted thumps. It also adds boost and sparkle to mid-range and high frequencies, critical for speech applications. Lastly, a compressor has been added to help control spoken audio levels. This plug-and-play mode is perfect for larger venue applications where speech is the primary audio source in need of clear and precise intelligibility.

CLUB Voicing Mode – This mode is full range, but focuses on increased bass and brilliant high frequencies. This is the place to start for most DJ / music playback applications.

MONITOR Voicing Mode – Monitor mode was designed primarily to remove unwanted low frequency buildup while also improving mid-range articulation for the artist(s). This mode should only be engaged when the speaker is in its monitor orientation and coupled with a stage or other hardwood floor... if not, the speaker won't sound right.

SRM210 | V-Class Frequency Graph

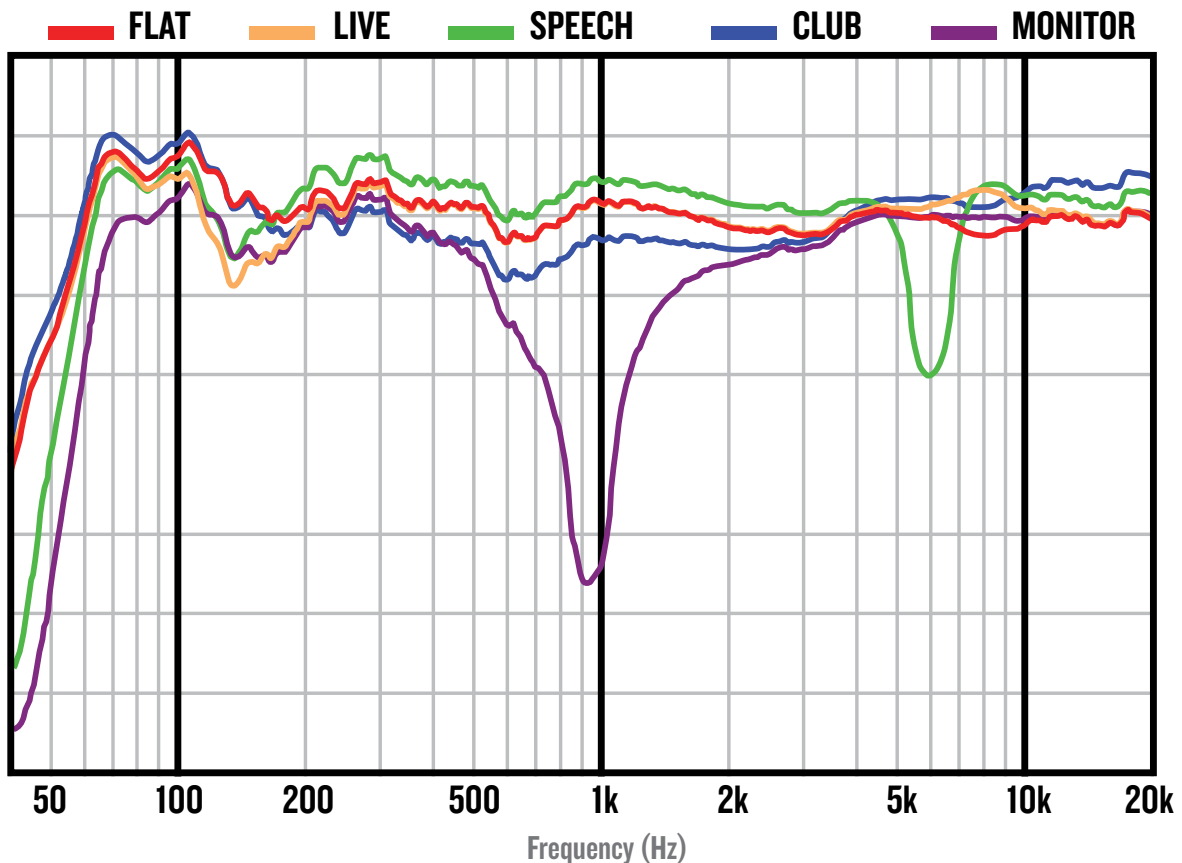

SRM212 | V-Class Frequency Graph

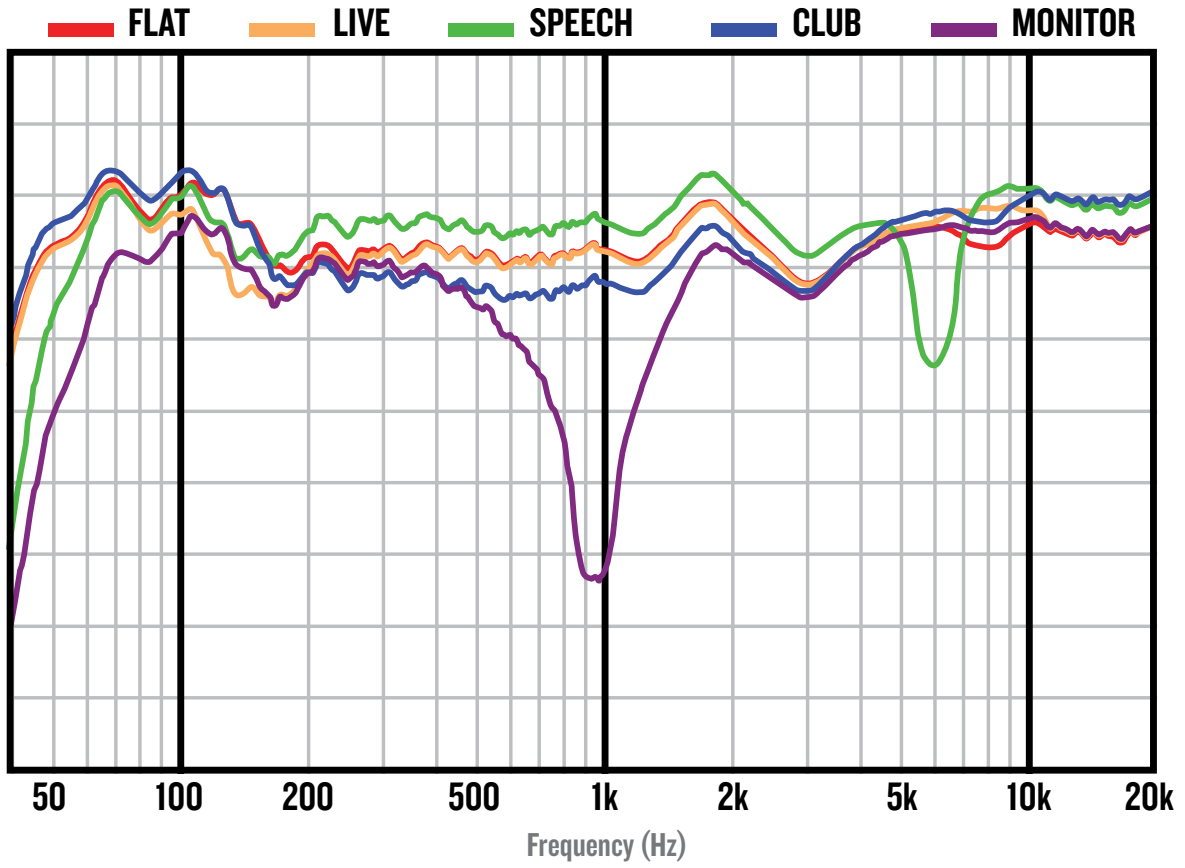

SRM215 | V-Class Frequency Graph

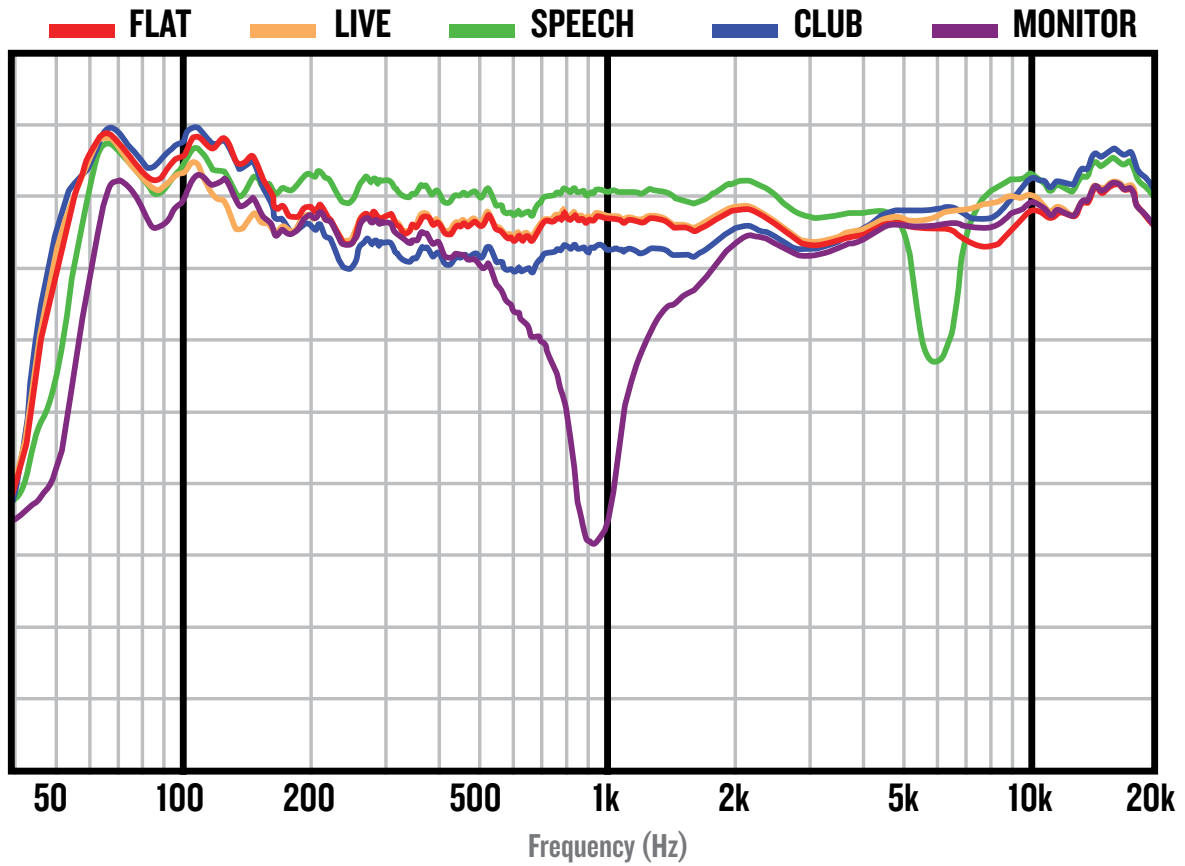

Polar Measurements of Horizontal Dispersion (MF + HF)

5 kHz

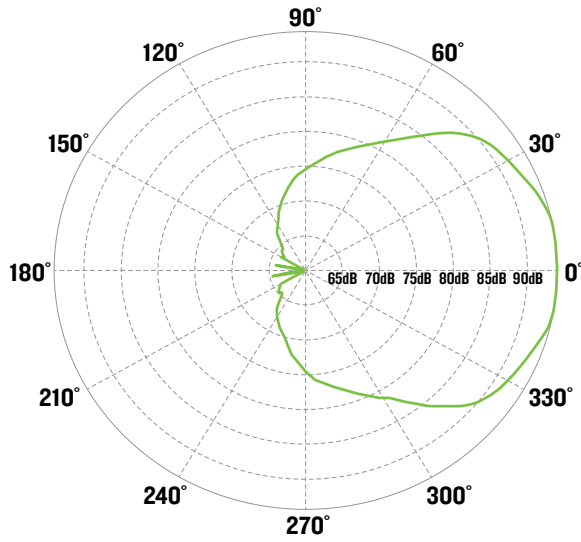

10 kHz

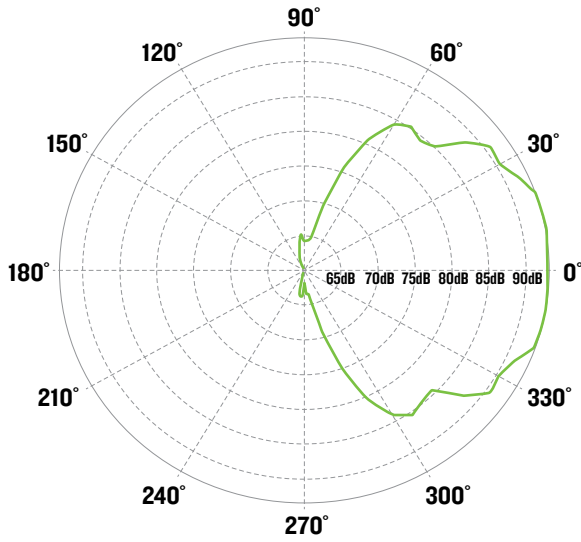

15 kHz

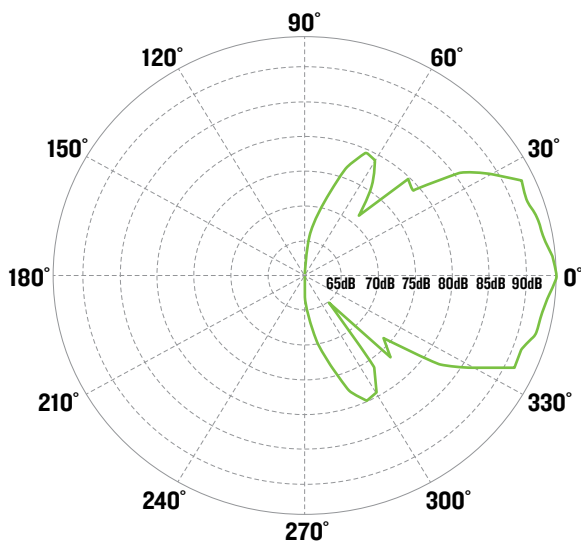

3D Measurements of Horizontal + Vertical Dispersion (MF + HF)

5 kHz

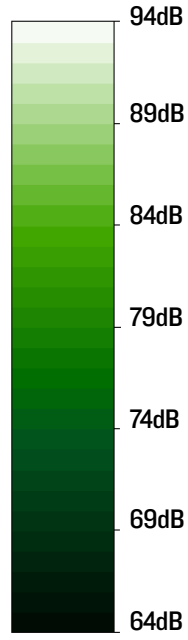
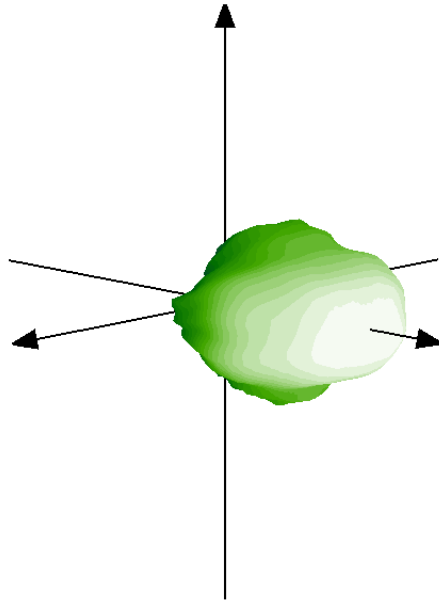

10 kHz

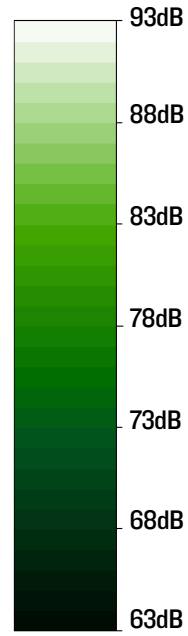
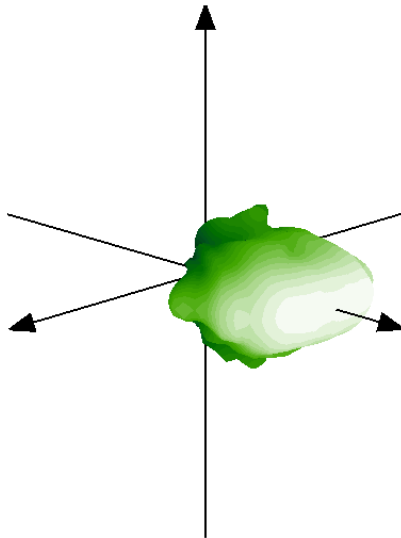

15 kHz

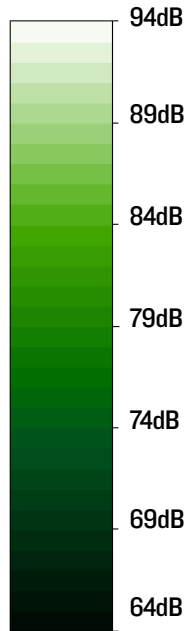
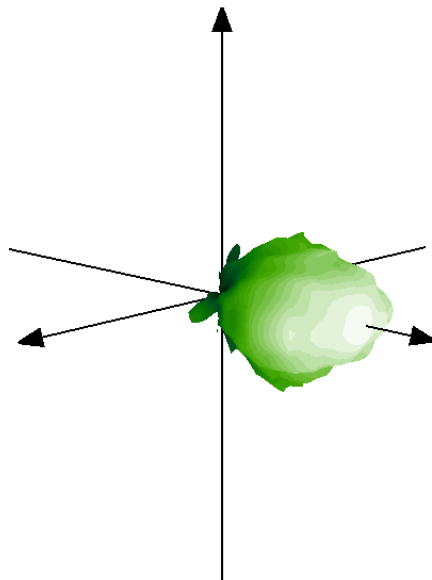

SRM | V-Class Loudspeakers Block Diagram – SRM Mix Control™

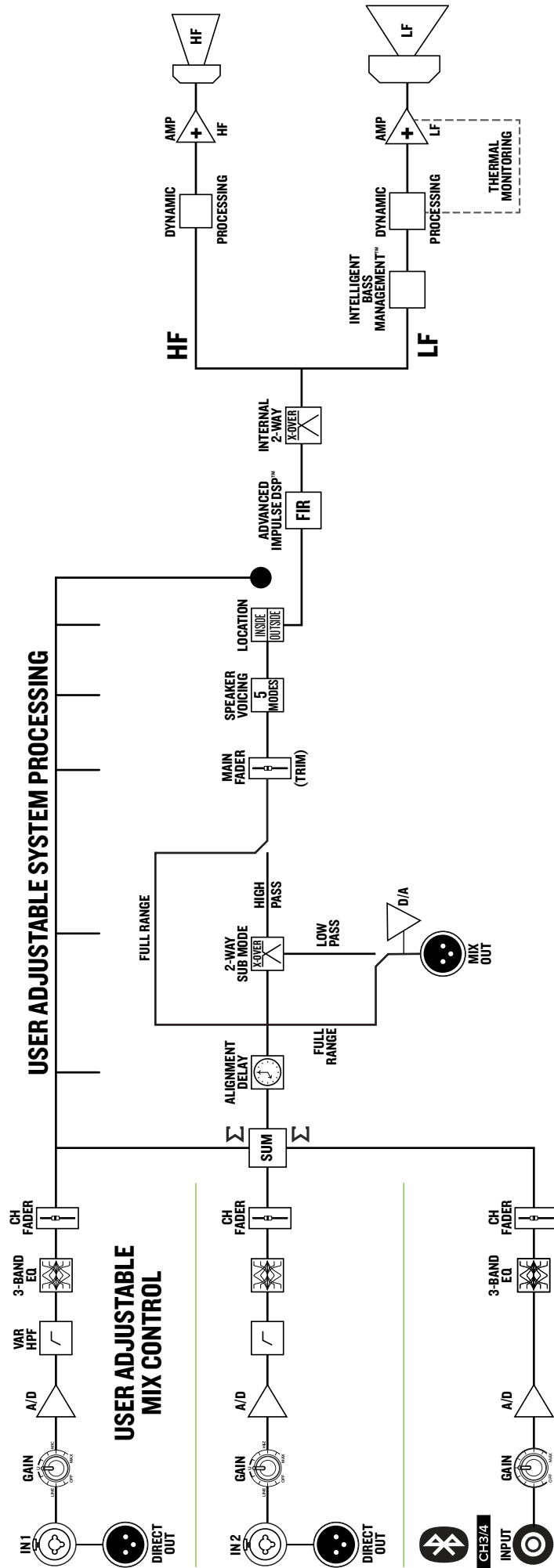

SRM210 | V-Class Loudspeaker Dimensions

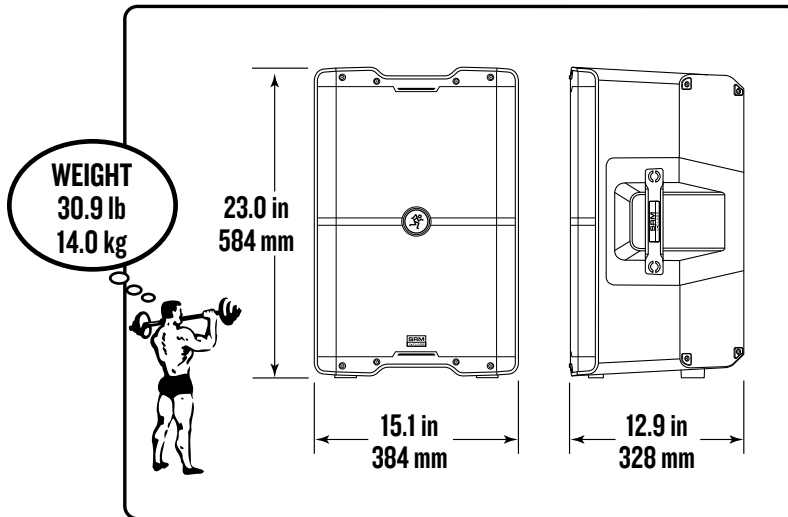

SRM212 | V-Class Loudspeaker Dimensions

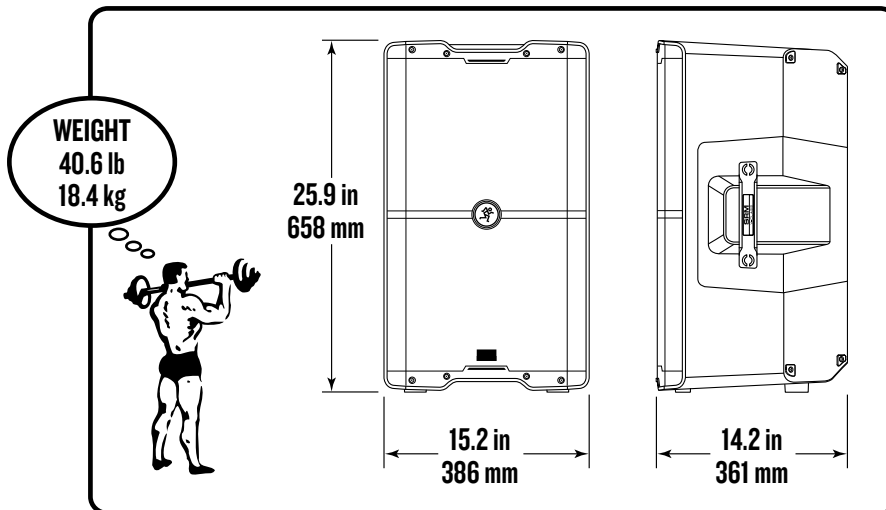

SRM215 | V-Class Loudspeaker Dimensions

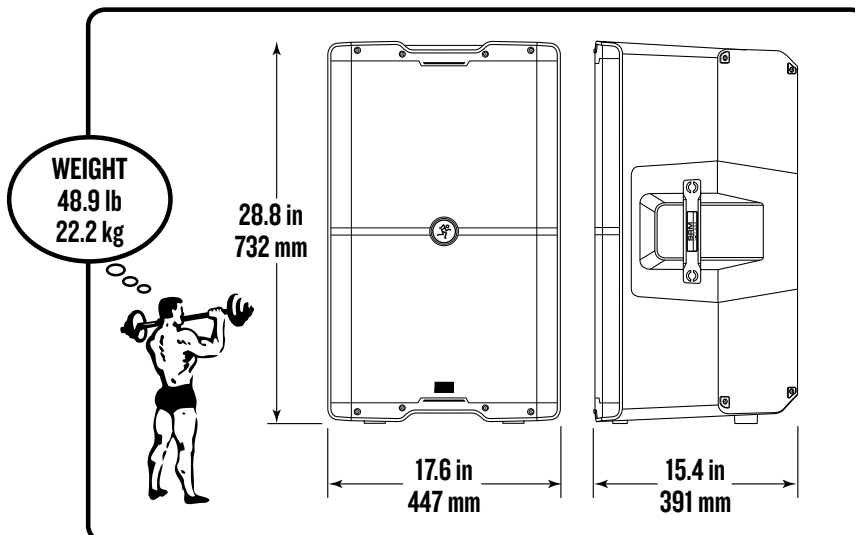

Limited Warranty

Please keep your sales receipt in a safe place.

This Limited Product Warranty (“Product Warranty”) is provided by LOUD Audio, LLC (“LOUD”) and is applicable to products purchased in the United States or Canada through a LOUD-authorized reseller or dealer. The Product Warranty will not extend to anyone other than the original purchaser of the product (hereinafter, “Customer,” “you” or “your”).

For products purchased outside the U.S. or Canada, please visit www.mackie.com to find contact information for your local distributor, and information on any warranty coverage provided by the distributor in your local market.

LOUD warrants to Customer that the product will be free from defects in materials and workmanship under normal use during the Warranty Period. If the product fails to conform to the warranty then LOUD or its authorized service representative will at its option, either repair or replace any such nonconforming product, provided that Customer gives notice of the noncompliance within the Warranty Period to the Company at: www.mackie.com or by calling LOUD technical support at 1.800.898.3211 (toll-free in the U.S. and Canada) during normal business hours Pacific Time, excluding weekends or LOUD holidays. Please retain the original dated sales receipt as evidence of the date of purchase. You will need it to obtain any warranty service.

For full terms and conditions, as well as the specific duration of the Warranty for this product, please visit www.mackie.com.

The Product Warranty, together with your invoice or receipt, and the terms and conditions located at www.mackie.com constitutes the entire agreement, and supersedes any and all prior agreements between LOUD and Customer related to the subject matter hereof. No amendment, modification or waiver of any of the provisions of this Product Warranty will be valid unless set forth in a written instrument signed by the party to be bound thereby.

Need help with the SRM | V-Class Loudspeakers?

- Visit www.mackie.com/support to find: FAQs, manuals, addendums, and other documents.
- Email us at: www.mackie.com/support-contact
- Telephone 1-800-898-3211 to speak with one of our splendid technical support chaps (Monday through Friday, normal business hours, Pacific Time).



**19820 North Creek Parkway #201
Bothell, WA 98011 • USA
Phone: 425.487.4333
Toll-free: 800.898.3211
Fax: 425.487.4337
www.mackie.com**
